

AT-1 / AT-1smartprint ECG unit

Service Handbook

SCHILLER AG
Altgasse 68
CH-6341 Baar, Switzerland
Phone: + 41 41 766 42 42
Fax: + 41 41 761 08 80
Home page: <http://www.schiller.ch/>



AT-1 / AT-1 smartprint Service Handbook

Article Number 2. 540022b

Issue a : March 2001

Issue b : June 2001

Associated Documents

Guide to the SCHILLER Interpretation
and Measurement Program E/ D/ F

Article No. 2. 510179

SCHILLER AT-1 / AT-1 smartprint User Guide - EDF

Article No. 2. 510171 e

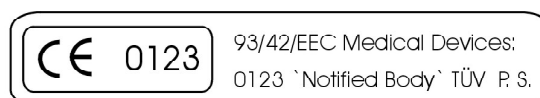

Windows™ is a trademark of Microsoft Corporation.



Where to Obtain Service

USA / Canada	WELCH ALLYN SCHILLER Inc., 7420 Carroll Road, San Diego, CA , US-92121-2334 USA	
	Tel.: +1 858 635 6023	Fax : +1 858 635 6611
	Home Page : www.welchallyn.com	
Asia Pacific	SCHILLER Asia Pacific, 10 Jalan SS 3/33, Taman Universiti, 47300 Petaling Jaya, Selangor, Malaysia	
	Tel.: + 603 7877 5336	Fax : + 603 7877 5744
Austria	SCHILLER HmbH, Kampmüllerweg 24, A-4044 Linz, Austria	
	Tel.: + 43 732 709 90	Fax : + 43 732 757 000
France	SCHILLER Medical S.A, BP 50, 19, Avenue de la Gare, F-67162 Wissembourg / Cedex, France.	
	Tel.: +33 3 88 63 36 00	Fax : +33 3 88 94 12 82
Germany (EU authorized representative)	SCHILLER Medizintechnik GmbH, Rudolf-Diesel Strasse 14, D-85521 Ottobrunn, Germany	
	Tel.: + 4989 629 981 0	Fax : + 4989 609 509 0
India	SCHILLER Healthcare India Pvt. Ltd., D.C.Silk Mills Compound, 'A' Wing, 1st floor, 5, Chunawala Estate, Kondivitta Lane, Andheri - Kurla Road, Andheri (E, Mumbai - 400 059, India	
	Tel.: + 9122 826 3520	Fax : + 9122 826 3525
Italy	ESAOTE Spa (SCHILLER), Via di Caciolle 15, I-50127 Firenze, Italy	
	Tel.: + 39055 4229 201	Fax : + 39055 4229 208
Switzerland	SCHILLER Reomed AG, Riedstrasse 14, CH-8953 Dietikon, Switzerland	
	Tel.: +411 744 3000	Fax : + 411 740 3710
All other countries	SCHILLER AG, Altgasse 68, CH-6341 Baar, Switzerland	
	Tel.: + 4141 766 4242	Fax : + 4141 761 0880
	Home Page : www.schiller.ch	

The SCHILLER sales and service centre network is worldwide. For the address of your local distributor, contact your nearest Schiller subsidiary. In case of difficulty a complete list of all distributors and subsidiaries is provided on our internet site or can be supplied from our head office.



Warranty

Terms of Warranty

The SCHILLER AT-1 / AT-1 smartprint is warranted against defects in material and manufacture for the duration of one year (as from date of purchase). Excluded from this guarantee is damage caused by an accident or as a result of improper handling. The warranty entitles free replacement of the defective part. Any liability for subsequent damage is excluded. The warranty is void if unauthorized or unqualified persons attempt to make repairs.

In case of a defect, contact your dealer or the manufacturer.

The manufacturer can only be held responsible for the safety, reliability, and performance of the apparatus if:

- * assembly operations, extensions, readjustments, modifications, or repairs are carried out by persons authorized by him, and
- * the ECG unit and approved attached equipment are used in accordance with the manufacturers instructions.

THERE ARE NO EXPRESS OR IMPLIED WARRANTIES WHICH EXTEND BEYOND THE WARRANTIES HEREINABOVE SET FORTH. SCHILLER MAKES NO WARRANTY OF MERCHANTABILITY OR FITNESS FOR A PARTICULAR PURPOSE WITH RESPECT TO THE PRODUCT OR PARTS THEREOF.

Physicians responsibility

THIS UNIT IS PROVIDED FOR THE EXCLUSIVE USE OF QUALIFIED PHYSICIANS OR PERSONNEL UNDER THEIR DIRECT SUPERVISION. THE NUMERICAL AND GRAPHICAL RESULTS AND ANY INTERPRETATION DERIVED FROM A RECORDING MUST BE EXAMINED WITH RESPECT TO THE PATIENTS OVERALL CLINICAL CONDITION. THE RECORDING PREPARATION QUALITY AND THE GENERAL RECORDED DATA QUALITY, WHICH COULD EFFECT THE REPORT DATA ACCURACY, MUST ALSO BE TAKEN INTO ACCOUNT.

IT IS THE PHYSICIANS RESPONSIBILITY TO MAKE THE DIAGNOSIS OR TO OBTAIN EXPERT OPINION ON THE RESULTS, AND TO INSTITUTE CORRECT TREATMENT IF INDICATED.



Safety Notices

NOTES

DO NOT USE SOLVENT CLEANERS.

THIS UNIT COMPLIES WITH EMC REGULATIONS FOR MEDICAL PRODUCTS WHICH AFFORDS PROTECTION AGAINST EMISSIONS AND ELECTRICAL INTERFERENCE. HOWEVER SPECIAL CARE MUST BE EXERCISED WHEN THE UNIT IS USED WITH HIGH FREQUENCY EQUIPMENT.

BEFORE USING THE UNIT, ENSURE THAT AN INTRODUCTION REGARDING THE UNIT FUNCTIONS AND THE SAFETY PRECAUTIONS HAS BEEN PROVIDED BY A PRODUCT REPRESENTATIVE.

CAUTIONS

SWITCH THE UNIT OFF BEFORE CLEANING AND DISCONNECT FROM THE MAINS.

THE DEVICE MUST ONLY BE OPERATED USING BATTERY POWER IF THE EARTH CONNECTION IS SUSPECT OR IF THE MAINS LEAD IS DAMAGED OR SUSPECTED OF BEING DAMAGED.

USE ONLY ACCESSORIES AND OTHER PARTS RECOMMENDED OR SUPPLIED BY SCHILLER AG. USE OF OTHER THAN RECOMMENDED OR SUPPLIED PARTS MAY RESULT IN INJURY INACCURATE INFORMATION AND / OR DAMAGE TO THE UNIT.

IT MUST BE ENSURED THAT NEITHER THE PATIENT NOR THE ELECTRODES (INCLUDING THE NEUTRAL ELECTRODE) COME INTO CONTACT WITH OTHER PERSONS OR CONDUCTING OBJECTS (EVEN IF THESE ARE EARTHED).

THERE IS NO DANGER WHEN USING THE ECG UNIT FOR A PACEMAKER PATIENT OR WITH SIMULTANEOUS USE OF OTHER ELECTRICAL STIMULATION EQUIPMENT. HOWEVER, THE STIMULATION UNITS SHOULD ONLY BE USED AT A SUFFICIENT DISTANCE FROM THE ELECTRODES. IN CASE OF DOUBT, THE PATIENT SHOULD BE DISCONNECTED FROM THE RECORDER.

IF SEVERAL UNITS ARE COUPLED THERE IS A DANGER OF SUMMATION OF LEAKAGE CURRENTS. WHEN OPERATING SEVERAL DEVICES FOR MEDICAL AND NON-MEDICAL APPLICATION DO NOT USE ANY EXTENSION CABLES OR DISTRIBUTION BOXES FOR THE CONNECTION.

EARTH MUST BE CONNECTED WHEN THE EXTERNAL PRINTER IS USED.



WARNINGS

SERVICING IS TO BE CARRIED OUT BY QUALIFIED PERSONNEL ONLY.

DO NOT USE THIS UNIT IN AREAS WHERE THERE IS ANY DANGER OF EXPLOSION OR THE PRESENCE OF FLAMMABLE GASES SUCH AS ANAESTHETIC AGENTS.

THIS PRODUCT IS NOT DESIGNED FOR STERILE USE.

THIS PRODUCT IS NOT DESIGNED FOR OUTDOOR USE.

DO NOT, UNDER ANY CIRCUMSTANCES, IMMERSE THE UNIT OR CABLE ASSEMBLIES IN LIQUID.

DO NOT USE HIGH TEMPERATURE STERILISATION PROCESSES (SUCH AS AUTOCLAVING). DO NOT USE E-BEAM OR GAMMA RADIATION STERILISATION.

THIS UNIT IS CF  CLASSIFIED ACCORDING TO IEC EN 60601-1. THIS MEANS THAT THE PATIENT CONNECTION IS FULLY ISOLATED AND DEFIBRILLATION PROTECTED. SCHILLER CAN ONLY GUARANTEE PROTECTION AGAINST DEFIBRILLATION VOLTAGE HOWEVER, WHEN THE ORIGINAL SCHILLER PATIENT CABLE IS USED.

DO NOT TOUCH THE CASING DURING DEFIBRILLATION.

IF THE PATIENT CABLE SHOULD BECOME DEFECTIVE AFTER DEFIBRILLATION, LEAD OFF WILL BE DISPLAYED AND AN ACOUSTIC ALARM GIVEN.



What is in this book

THE SERVICE PHILOSOPHY FOR ALL SCHILLER UNITS IS FAULT FINDING TO MODULE LEVEL ONLY. THE PURPOSE OF THIS BOOK IS TO PROVIDE ALL THE INFORMATION NECESSARY TO ENABLE THE SERVICE ENGINEER TO EFFICIENTLY LOCATE AND REPLACE A FAULTY MODULE. THIS BOOK ASSUMES NO DETAILED KNOWLEDGE OF THE ECG UNIT BUT DOES REQUIRE THAT THE SERVICE ENGINEER IS FAMILIAR WITH STANDARD WORKSHOP PRACTICES.

The book is divided into the following chapters:

Chapter 1 - Operating Elements

The purpose of this chapter is to provide an easy reference for all main operator functions and to give a basic introduction to the AT-1 / AT-1smartprint. This chapter gives details of the operator controls with the operation and function of each key briefly explained. The information in this chapter provides a background to the operating functions only. Complete operating information is provided in the SCHILLER AT-1 / AT-1 smartprint User Guide.

Chapter 2 - Functional Overview

This chapter provides a functional overview of the AT-1 / AT-1 smartprint. The description is supported by functional block diagrams.

Chapter 3 - Fault Diagnosis

This chapter provides a guide to locate a fault to module level. The diagnostics are presented in a logical sequence of fault finding algorithms and procedures. Illustrations are provided to support the text where needed.

Chapter 4 - Module Removal and Replacement

This chapter gives an overview of the physical construction of the AT-1 / AT-1 smartprint with the main physical attributes of the unit briefly described. The physical description is supported by illustrations showing the internal location of all modules. Removal and replacement instructions for all removable modules are also provided in this chapter. Each procedure is autonomous with details of tools, jumper settings, adjustments and settings or special requirements that are required before and after replacement. Functional checks that must be carried out after replacing a module are also provided.

Chapter 5 - Adjustments

This chapter provides all adjustments and settings. Also detailed in this chapter are basic functional test procedures that can be performed to check the functioning of the unit.

Chapter 6 - Spare Parts

This chapter provides the part numbers and reordering information for all replaceable modules. Also included in this chapter are details of any special test equipment or special tools required for adjustment or fault finding procedures.



What's in this book

Chapter 7 - Technical Data







The full technical specification of the AT-1 / AT-1 smartprint is given in this chapter.

Index

Circuit Diagrams & Board Layouts

The circuit diagrams and component layouts are provided for all boards. These details are provided for information only.

General Symbols

	Mains connected		Type CF equipment - safe for internal applications. NOTE: The paddles indicate that the equipment is defibrillator proof.
	Battery operation (Flashes when battery capacity limited)		ON / OFF
	Potential Equalisation (common ground)		93/42/EEC Medical Devices: 0123 'Notified Body' TÜV.P.S.
	Attention - General warning sign - see accompanying text.		



Contents

Associated Documents	2
Where to Obtain Service	3
Warranty	4
Safety Notices	5
What is in this book	7
CHAPTER 1 OPERATING ELEMENTS	11
Introduction	12
Location & Power	13
The Keyboard	14
AT-1/AT-1smartprint Short Form Operating Instructions	15
Manual ECG Recording (internal printer only)	15
System Configuration	15
Automatic ECG Recording	
with external printer connected and switched on:	15
with external printer NOT connected or switched off:	15
Modes of Operation	16
Automatic Mode	16
Manual Mode	16
Automatic Mode	17
a. without external printer connected or printer switched off	17
b. with external printer	18
Settings	20
Default Settings	22
Language	23
Filters	24
Baseline Filter	24
Mains Filter	24
Myogram Filter	25
Defining Lead Sequence & Printout	26
Acoustic QRS Indication	27
Time / Date	27
Automatic Mode (ECG) Settings, Internal Printer	28
Average Cycles	28
Measurements and Markings (M and C versions only)	29
Interpretation (C version only)	29
Automatic Mode (ECG) Settings, External Printer	30
Average Cycles	30
Measurements and Markings (M and C versions only)	31
Interpretation (C version only)	31



Automatic Mode (ECG) Settings	32
Interpretation Settings (C version only)	32
Selecting Rhythm Leads	33
Service Printout	34
Installing Software Options	35
Care & Maintenance	36
Replacing the Recording Paper in the Internal Printer	37
Thermal Paper Handling	38
CHAPTER 2 FUNCTIONAL OVERVIEW	39
Main Board MK 11-10	42
CHAPTER 3 FAULT DIAGNOSIS	45
Fault Diagnosis Chart	46
General Functional Check Procedures	48
Internal Printer Check	49
CHAPTER 4 MODULE REMOVAL AND REPLACEMENT	51
Warnings and Cautions	54
Physical Overview	55
Opening the Case	56
Top Housing Replacement	57
Physical Overview	58
ECG Interface Board MK 11-2	59
Printer Tray Assembly and Thermal Printer	60
Thermal Printer Removal	61
Control and Power Supply Board MK 11-10	62
Battery Pack	64
Keyboard	66
CHAPTER 5 ADJUSTMENTS	67
Introduction	68
Warnings, Cautions and Conditions	69
Test Equipment	70
Battery Charge Voltage	71
ECG Amplifier Reference Voltage	72
CHAPTER 6 SPARE PARTS	75
Ordering Information	76
Spare Parts	77
CHAPTER 7 TECHNICAL DATA	79
Technical Data	80
Index	83



Chapter 1

Operating Elements



Introduction

The AT-1 / AT-1 smartprint is a 3-channel ECG recorder with all (12) ECG signals simultaneously processed to provide instant ECG recordings. Three automatic recording modes - two for the internal printer and one for the external printer - can be individually preset to enable one button ECG recording of preferred print formats.

Individual lamps are provided to give power, paper error, filter, lead group and lead off indications. In addition, any detected disturbance (i.e. loose electrode or end of paper), gives an audible alarm and the corresponding indicator lamp flashes.

The AT-1 / AT-1 smartprint includes the following features:

- Low weight and compact dimensions
- Printout from integrated quality thermal printer - OR - from external A4 inkjet printer
- Built-in rechargeable battery for mains-independent use - 2 hrs normal use on one battery charge
- Simple one key operation for main functions
- Automatic or manual recording modes
- Selectable printing formats - external and internal printer
- Interpretation program option (including measurements) for children and adults
- Choice of 10 languages (AT-1) and 9 languages (AT-1 smartprint) for printing.



Location & Power

Location

Do not keep or operate the device in a wet, moist, or dusty environment. Also avoid exposure to direct sunlight or heat from other sources. Do not allow the unit to come into contact with acidic vapours or liquids, as such contact may cause irreparable damage. The unit should not be placed near X-ray or diathermy units, large transformers or motors. The unit must be placed on a flat surface and must not be operated in areas where there is any danger of explosion.

Power Supply

The mains connection is on the rear of the unit. The mains indicator lamp on the keyboard is always lit when the unit is connected to the mains supply. The unit can either be operated from the mains supply or from the built-in rechargeable battery. The power source is indicated by the respective indicator lamp. When battery capacity is limited, the battery symbol flashes on and off.

To recharge the battery, connect the device to the mains supply by means of the supplied power cable. A totally discharged battery needs less than 15 hours to be fully recharged (60% in less than 3 hours, 90% in less than 7 hours). A fully charged battery gives approximately 2 hours of normal use. The unit can remain connected to the mains supply without any danger of damage to either the battery or the unit.

Switching On and Off

The AT-1 / AT-1 smartprint is switched on with the green ON key



and off by means of the red OFF key



The unit is automatically switched off after 5 minutes (30 seconds if battery capacity is limited) if no key is pressed and the patient cable is not connected.

Potential Equalisation

If the AT-1 / AT-1 smartprint is used in conjunction with other patient connected equipment, we recommend that the potential equalisation stud on the rear of the unit is connected to the building common ground with the yellow/green ground cable (Part-no. 2.310005). When working from an emergency vehicle, the vehicle common ground can be used.

WARNING !

THE UNIT MUST BE GROUNDED WHEN THE EXTERNAL PRINTER IS CONNECTED.



The Keyboard

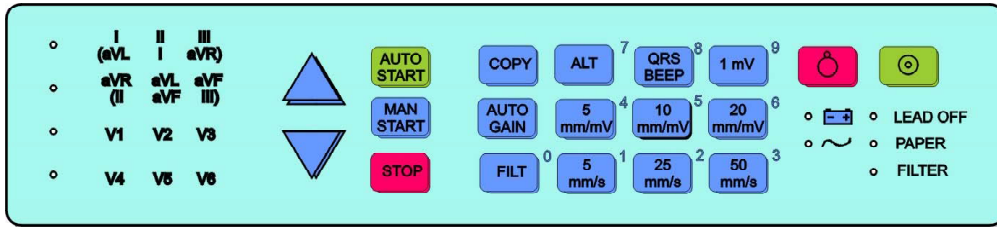

- Switch unit on
- Switch unit off
- Copy stored ECG (printer)
- Start automatic recording
- Start manual recording
- Stop recording
- Switch myogram filter (muscle tremor filter) on or off
- Lead group selector (backward)
- Lead group selector (forward)
- Cancel or enable QRS beeper
- Automatic ECG sensitivity adjustment in order to avoid overlapping traces - in automatic mode only
- ECG sensitivity selector (5, 10 or 20 mm/mV) auto and manual recording
- ECG sensitivity selector (5, 10 or 20 mm/mV) auto and manual recording
- ECG sensitivity selector (5, 10 or 20 mm/mV) auto and manual recording
- Chart speed selector (5, 25 or 50 mm/s) manual recording only
- Chart speed selector (5, 25 or 50 mm/s) manual recording only
- Chart speed selector (5, 25 or 50 mm/s) manual recording only
- Key for 1 mV mark on output during manual recording. Use this key also for baseline recentering.
- Key for initiation of setups and selection of second format for printout

- Mains indicator (lit when mains connected)
- Battery indicator (lit when running on battery power - mains not connected), blinking when battery capacity is getting low
- Warning lamp for loose electrode connection or poor electrode contact
- Warning lamp for end of paper or paper jam
- Myogram filter (lit when filter is ON)
- Indicator lamp for selected lead group (standard) in manual mode only
- Indicator lamp for selected lead group (standard) (Cabrera: aVL, I, -aVR, II, aVF, III) in manual mode only
- Indicator lamp for selected lead group in manual mode only
- Indicator lamp for selected lead group in manual mode only



AT-1/AT-1smartprint Short Form Operating Instructions

Automatic ECG Recording
with external printer connected and switched on:
Prepare skin, hook up patient.

Switch unit on, press ON



Press AUTO to record and print externally



with external printer NOT connected or switched off:

To record and print on internal printer:

For AUTO Format 1 press



For Auto Format 2 press ⁷ and then



Press COPY for additional copies.



Manual ECG Recording (internal printer only)

Prepare skin, hook up patient.

Switch unit on, press ON



Press MAN START



Change lead group with



Press STOP to stop the printout.



Electrode hook-up check

Press ⁷ ⁰ ³ ³ for print-out of electrode dc offsets.

Best results are obtained when the electrode voltage readings (right column) are between +50mV and -50mV.

Filter On/Off

Press ⁰ to switch the (Myogram) filter On / Off.

System Configuration

Press ⁷ ⁰ ¹ ¹ to print system settings.



Modes of Operation

Automatic Mode

a. without external printer connected or printer switched off

Automatic Mode provides a printout giving 10 seconds of ECG recording of all 12 leads with a choice of 2 different formats (only for S version).

The following can be programmed freely for each of the 2 formats before recording:

- Lead Format
- Chart Speed
- With the optional interpretation program installed it is also possible to select the measurement table, average cycles with optional markings and interpretation statements for the printout.

For further information see paragraph `Automatic Mode (ECG) Settings` on page 28.

b. with external printer connected and switched on

Only one Automatic Mode format possible. Other details as above.

For further information see paragraph `Automatic Mode (ECG) Settings` on page 30.

Manual Mode

Manual Mode provides a real time print-out of 3 selected leads and is only possible on the internal thermal printer.

The following can be freely selected before or during recording:

- Lead Group
- Chart Speed
- Sensitivity
- Myogram Filter

For further information see paragraph `Manual Mode` on page 19.



Automatic Mode

a. without external printer connected or printer switched off

In automatic mode, a full 12-lead ECG is printed in one of two predefined formats with selectable sensitivity. These formats (see Settings) are selected by the user to suit his specific needs and requirements.

When the AUTO GAIN key  is pressed before recording in automatic mode, the unit detects very large waveform amplitudes and sets the sensitivity for the extremity and/or precordial leads accordingly to reduce the overlapping of traces.

To start the automatic ECG recording in Format 1, press the AUTO START key:



To start the automatic recording in Format 2, press the ALT key followed by the AUTO START key:

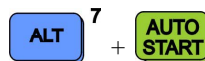

Depending upon which option is included, the printout gives the following:

- ECG recording of all leads in either Standard or Cabrera format according to selection
- Sensitivity
- Heart Rate
- Speed
- Filter Settings
- Interpretation statements (with option C)
- Average Cycles (with options M, C)
- Intervals (with options M, C)
- Axes (with options M, C)
- Detailed Measurement Table (with options M, C)

To obtain an extra printout of the ECG recording in Format 1, simply press the COPY key:

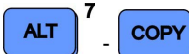

To obtain an extra printout of the second format, press the ALT key followed by the

COPY key: 

Note: The Auto mode settings for the two formats are detailed in the paragraph entitled 'Automatic Mode (ECG) Settings` later in this chapter.



Automatic Mode

b. with external printer

With the external printer connected and switched on, only one Auto Mode format (selectable) is available.

To start the automatic ECG recording in Automatic Mode, press the AUTO START key:



For further information see paragraph `Automatic Mode (ECG) Settings` on page 30.



Manual Mode

Manual mode provides a real-time ECG printout of 3 selected leads with full control of parameter selection. This is only possible on the internal thermal printer.

To start the manual recording of a real-time ECG, press the MAN START Printout key





To stop the manual recording (printout) press the STOP key



The printout provides you with the following:

- Three (selected) leads with lead identification.
- On the lower edge, the chart speed and filter settings (if on).
- At the top, the heart rate as current average of 4 beats, trace sensitivity.

The following can be freely chosen during or before the recording:

Lead Group by means of the LEAD FORWARD 
and LEAD BACKWARD key 

The following lead groups are selectable:

- I, II, III aVR, aVL, aVF
(Cabrera: aVL, I, -aVR / II, aVF, III)
- V1, V2, V3 / V4, V5, V6

Chart Speed Select speed 5, 25 or 50 mm/s by means of the SPEED keys:



Sensitivity Select 5, 10 or 20 mm/mV by means of the SENSITIVITY keys:

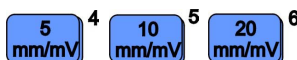

Myogram Filter Switch the filter ON or OFF with the FILTER key: 
25 Hz or 35 Hz is displayed on the bottom line of the printout when the filter is switched on.

Recentering To re-centre the ECG traces, press the 1mV key 



Settings

Each parameter is set by means of a code. This code comprises a combination of keys starting with the ALT key followed by two or three numbers. The setting is confirmed with the STOP key. As soon as the ALT key is pressed, the keyboard is dedicated to the programming function.

Note: The Alternative (ALT) function is only active for 4 seconds. If a programming key is not pressed within 4 seconds, the unit reverts to standard mode. The ALT key must again be pressed to activate the programming mode

The setting is remembered and the keyboard released for other functions when the STOP key is pressed. Once a setting has been confirmed, it is stored in the memory even when the unit is switched off.

Example

If you want to set the language on your ECG unit to English, the key sequence given in the table (see page 23), is

ALT - 0 - 2 - 2 - STOP.

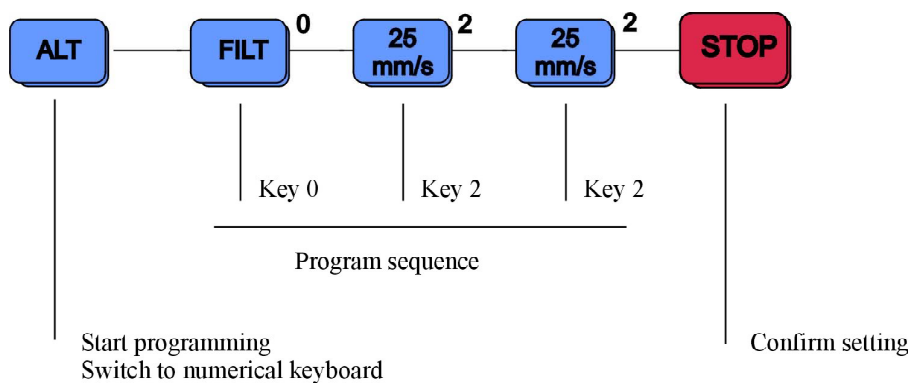

On the following pages the programmable parameters and the programming sequences are described in detail.



Settings (cont.)

The defined formats and settings for your unit can be checked as follows:

ALT - 0 - 1 - any number

A printout of the defined settings will be produced and gives the following information, depending on the installed software.

SETUP OF CARDIOVIT AT-1smartprint	
AT-1s C (V.1.01) 5.70	
Serial nbr : unknown	leads : S
Format 1 ECG : 25 mm/s o	
M ECG : 2*6 (50 mm/s) + 1	
measurements: - marks: +	
Interpretation: +	
Format 2 ECG : 25 mm/s ooo	
M ECG : -	
measurements: - marks: +	
Interpretation: -	
Rhythm leads : V1 II	
Autom. Centering: + Paper: z-fold	
Signals : sequential	
Baseline filter : 0.05 Hz	
Mainsfilter : 50 Hz	
Myo-filter : 35 Hz -	
Interp: N/R: - U: + A30: - S: -	

External printer :	
Format ECG : 25 mm/s o	
M ECG : 2*6 (50 mm/s) + 2	
measurements: - marks: +	
interpretation: +	

Unit designation	Software version, Software option installed (C = Interpretation) and interpretation version
Serial number	Serial number of the unit
Leads	Standard (S) or Cabrera (C)
ECG Format	Long (ooo), Short (o) or Suppressed (-)
M ECG	Average cycles as defined in auto ECG recording setup (e.g. 4 * 3 (25 mm/s) + 2)
Measurements	Enabled (+) or Suppressed (-)
Marks	Enabled (+) or Suppressed (-)
Interpretation	Enabled (+) or Suppressed (-)
Selected Rhythm leads	Leads selected for R1 and R2
Automatic Centering	Enabled (+) or Suppressed (-)
Paper type	Z-folded
Printout of signals	Sequential or Simultaneous
Baseline Filter	0.05, 0.15 or 0.30 Hz
Mains Filter	50, 60 Hz or OFF (-)
Myogram Filter	25 or 35 Hz, ON (+) or OFF (-)
Interpretation settings:	N/A: +/- 'normal/abnormal' is written (+) or suppressed (-)
	U: +/- 'unconfirmed report' is written (+) or suppressed (-)
	A30: +/- patient age is assumed to be < 30 (-) or >30 (+)
	S: +/- low (-) or high (+) sensitivity



Settings (cont.)

Default Settings

To reset the unit to the basic default settings, proceed as follows:

ALT - 0 - 6 - 6

SETTINGS	S = STANDARD	M = MEASUREMENTS	C = WITH INTERPRETATION
LANGUAGE	AS SET	AS SET	AS SET
LEADS	STANDARD (S)	STANDARD (S)	STANDARD (S)
AUTO FORMAT 1	ECG: 25MM/S, SHORT (O)	ECG : 25MM/S, SHORT (O)	ECG : 25MM/S, SHORT (O)
		M ECG :6*2 (50MM/S + 1)	M ECG: 6*2 (50MM/S + 1)
	PATIENT DATA FORM ENABLED +	MEASUREMENTS: SUPRESSED (-)	MEASUREMENTS: SUPRESSED (-)
		MARKS: ENABLED (+)	MARKS: ENABLED (+)
AUTO FORMAT 2	ECG: 25MM/S, LONG (OOO)	ECG : 25MM/S, LONG (OOO)	ECG : 25MM/S, LONG (OOO)
		M ECG: --	M ECG: NONE
	PATIENT DATA FORM ENABLED +	MEASUREMENTS: SUPRESSED (-)	MEASUREMENTS: SUPRESSED (-)
		MARKS: ENABLED (+)	MARKS: ENABLED (+)
RHYTHM LEADS		V1, II	V1, II
AUTOM. CENTERING	ENABLED (+)	ENABLED (+)	ENABLED (+)
PAPER	Z - FOLD	Z - FOLD	Z - FOLD
PRINTOUT OF SIGNALS	SEQUENTIAL	SEQUENTIAL	SEQUENTIAL
BASELINE FILTER SETTING	0.05HZ	0.05HZ	0.05HZ
MAINS FILTER SETTINGS	50HZ (60HZ)	50HZ (60HZ)	50HZ (60HZ)
MYOGRAM FILTER SETTING	35HZ, OFF (-)	35HZ, OFF (-)	35HZ, OFF (-)
INTERPRETATION SETTINGS			N/A: SUPRESSED (-)
			U: ENABLED (+)
			A30: UNDER THIRTY (-)
			S: LOW (-)
EXTERNAL PRINTER	ECG: 25MM/S, SHORT (O)	ECG : 25MM/S, SHORT (O)	ECG : 25MM/S, SHORT (O)
		M ECG: 6*2 (50MM/S) + 2	M ECG: 6*2 (50MM/S) + 2
	PATIENT DATA FORM ENABLED +	MEASUREMENTS: SUPRESSED (-)	MEASUREMENTS: SUPRESSED (-)
		MARKS: ENABLED (+)	MARKS: ENABLED (+)
		INTERPRETATION: ENABLED (+)	



Settings (cont.)

Language

The language is selected as follows:

Language Selection AT-1					
Entry Key Sequence			Language	Confirm	
ALT	0	2	1	German	Press STOP key
			2	English	
			3	French	
			4	Swedish	
			5	American	
			6	Italian	
			7	Spanish	
			8	Portugese	
			9	Dutch	
			0	Russian	

Language Selection AT-1 smartprint					
Entry Key Sequence			Language	Confirm	
ALT	0	2	1	German	Press STOP key
			2	English	
			3	French	
			4	Swedish	
			5	American	
			6	Italian	
			7	Spanish	
			8	Portugese	
			9	Dutch	

Confirm the selection by pressing



*Notes: The difference between English and American is the mains filter setting -
English = 50Hz; American = 60Hz and the physical units.*



Settings (cont.)

Filters

There are three different filters which can be set individually as follows:

- Baseline filter
- Mains filter
- Myogram filter

Baseline Filter

The digital Baseline filter suppresses excessive baseline drifts. The setting options are as follows:

Baseline Filter				
Entry Key Sequence			Filter Setting	Confirm
ALT	5	0	0.05 Hz (default)	Press STOP key
		1	0.15 Hz	
		3	0.30 Hz	

Confirm the selection by pressing



Note: The set value is the lower limit of the frequency range and is normally set to 0.05 Hz. The settings 0.15 and 0.30 Hz should only be used when absolutely necessary, as the possibility exists that they could affect the original ECG signal, especially the ST segments.

Mains Filter

The Mains filter is an adaptive digital interference filter designed to suppress AC interference without attenuating or distorting the ECG.

Set the mains filter in accordance with the frequency of your local mains supply as follows:

Mains Filter				
Entry Key Sequence			Filter Setting	Confirm
ALT	8	5	Mains Filter 50 Hz	Press STOP key
		6	Mains Filter 60 Hz	
		9	Mains Filter Off	



Settings (cont.)

Myogram Filter

The Myogram filter suppresses disturbances caused by strong muscle tremor. The set value will be the new upper limit of the frequency range as soon as the FILTER key is pressed on or programmed as default when the unit is switched on. When the Myogram filter is on, the value, i.e. 35 Hz is displayed on the bottom line of the printout.

Myogram Filter				
Entry Key Sequence		Setting		Confirm
ALT	8	2	Myogram Filter 25 Hz	Press STOP key
		3	Myogram Filter 35 Hz	
		1	Myogram Filter active when the unit is first switched on (marked on printout with +)	
		8	Myogram Filter off when the unit is first switched on (marked on printout with -)	

Confirm the selection by pressing the STOP key



The myogram filter is switched on and off manually with the FILTER KEY



Note: An ECG recorded in auto mode is stored unfiltered. It is therefore possible to print the stored ECG either with or without passing the myogram filter. Filter ON is indicated in the bottom information line of the printout. When the FILTER key is pressed again, the filter is switched off and the `35 Hz` indication on the bottom information line of the printout is removed. The cutoff frequency of the myogram filter is set to either 25 or 35 Hz.



Settings (cont.)

Defining Lead Sequence & Printout

The required settings can be selected as follows:

Sequences, Print & Auto-centering				
Entry Key Sequence		Definition		Confirm
ALT	7	1	Standard Lead Sequence	Press STOP key
		2	Cabrera Lead Sequence	
		3	Simultaneous Print	
		4	Sequential Print	
		5	Auto-centering ON	
		6	Auto-centering OFF	
		7	Z-fold paper	

Confirm the selection by pressing the STOP key



The selectable printout forms are:

- Simultaneous** All ECG leads are printed in the same time segment (in automatic mode only).
- Sequential** Each group is a contiguous time segment of approximately 2.5 or 5 seconds (in automatic mode only).
- Auto-Centering ON** All ECG traces are centred dynamically for optimal use of paper width.
- Auto-Centering OFF** ECG traces are set to a fixed baseline position and may possibly overlap.

The Standard and Cabrera lead groups available for the AT-1 / AT-1smartprint are:

Lead Groups							
Standard				Cabrera			
I	aVR	V1	V4	aVL	II	V1	V4
II	aVL	V2	V5	I	aVF	V2	V5
III	aVF	V3	V6	-aVR	III	V3	V6



Settings (cont.)

Acoustic QRS Indication

The acoustic QRS beep can be switched on or off at any time by pressing the QRS BEEP key.



Time / Date (AT-1 smartprint only)

The required settings can be selected as follows:

Setting the Time and Date						
	Key Sequence				Enter Data	Confirmation
Time	ALT	0	5	1	HHMMSS	beep
Date	ALT	0	5	2	DDMMYY	beep

Seasonal Time Variation				
Time change	Key Sequence			
Wintertime to Summertime (+1Hr)	ALT	0	5	4
Summertime to Wintertime (-1Hr)	ALT	0	5	5

Note: If the battery has been disconnected for more than half an hour, the clock oscillator must be restarted before setting the time. To do this the following key sequence must be pressed:

ALT - 0 - 5 - 9

This will start the oscillator and the time can be set.

Note: The time and date only appear on the AUTO printout from the external printer.



Automatic Mode (ECG) Settings, Internal Printer

Two separate Auto formats can be defined for the internal printer in the AT-1 / AT-1smartprint. When defining auto format 1 the key sequence

ALT - 1

precedes the setting. When defining auto format 2 the key sequence

ALT - 2

precedes the setting.

The automatic mode formats are detailed on the following pages. The ECG format is set as follows:

ECG Format Internal Printer					
Entry Key Sequence			Printout		Confirm
ALT	1 or 2	1	5	No leads printed	Press STOP key
			6	Leads are printed in short form (3 sheets)	
			7	Leads are printed in long form (6 sheets)	
			8	Chart Speed 25mm/s	
			9	Chart Speed 50mm/s	

Average Cycles

The Average cycles are defined as follows:

Note: Lead selection for the rhythm lead(s) is defined on page 33.

Average Cycles (interpretation option only) Internal printer					
Entry Key Sequence			Printout		Confirm
ALT	1 or 2	2	5	No average lead cycles are printed	Press STOP key
			6	4 x 3 (25 mm/s). The average complexes are printed in 4 groups of three leads at a chart speed of 25mm/s	
			7	4 x 3 (50 mm/s). The average complexes are printed in 4 groups of three leads at a chart speed of 50mm/s	
			8	6 x 2 (50 mm/s) + 1 rhythm lead (25mm/s). The average complexes are printed in 6 groups of two leads at a chart speed of 50mm/s	
			9	12 x 1 (25 mm/s) + 2 rhythm leads (25mm/s). The average complexes are printed out for all 12 leads at a chart speed of 50mm/s	



Automatic Mode (ECG) Settings, Internal Printer (cont.)

Measurements and Markings (M and C versions only)

To define the measurements and markings proceed as follows:

Measurements (M and C Options Only) Internal printer					
Entry Key Sequence			Printout		Confirm
ALT	1 or 2	3	5	Detailed table of measurement results omitted - however, the values of electrical axes, intervals, and heart rate are not suppressed.	Press STOP key
			6	Detailed table of measurement results is printed	
			7	Reference markings are omitted	
			8	Reference markings (beginning and end of P wave and QRS, and end of T wave) are added to the ECG average cycles	

Interpretation (C version only)

To print or suppress interpretation statements on the printout proceed as follows:

Interpretation (Interpretation Option Only) Internal printer					
Entry Key Sequence			Printout		Confirm
ALT	1 or 2	4	5	Interpretation is omitted	Press STOP key
			6	Interpretation is printed	

Confirm the selection by pressing the STOP key



Full details of the interpretation option are given in the SCHILLER ECG Measurement and Interpretation booklet (art. No. 2.510 179).



Automatic Mode (ECG) Settings, External Printer

One Auto format can be defined for the external printer in the AT-1smartprint. When defining the auto format the key sequence

ALT - 9

precedes the setting.

The automatic mode format is detailed on the following pages. The ECG format is set as follows:

ECG Format External printer					
Entry Key Sequence			Printout		Confirm
ALT	9	1	1	1 page A4 with 12 leads at 25mm/s (1x12)	Press STOP key
			2	One page with the first 8 leads printed for 5s and the last 4 leads printed for 10s	
			5	No leads printed	
			6	1 page A4 with 12 leads printed in short form (2x6)	
			7	2 pages A4 each with 6 leads printed in long form (6 + 6)	
			8	Chart Speed 25mm/s	
			9	Chart Speed 50mm/s	
			0	1 page A4 with 4 groups of 3 leads (4x3) at 25mm/s + 1 rhythm (25mm/s)	

Average Cycles

The Average cycles are defined as follows:

Note: Lead selection for the rhythm lead(s) is defined on page 33

Average Cycles (interpretation option only) External printer					
Entry Key Sequence			Printout		Confirm
ALT	9	2	5	No average lead cycles are printed	Press STOP key
			6	4 x 3 (25 mm/s) + 2 rhythm leads (25mm/s). The average complexes are printed in 4 groups of three leads at a chart speed of 25mm/s	
			7	4 x 3 (50 mm/s) + 2 rhythm leads (25mm/s). The average complexes are printed in 4 groups of three leads at a chart speed of 50mm/s	
			8	6 x 2 (50 mm/s) + 2 rhythm leads (25mm/s). The average complexes are printed in 6 groups of two leads at a chart speed of 50mm/s	
			9	12 x 1 lead (25mm/s) + 2 rhythm leads (25mm/s)	



Automatic Mode (ECG) Settings, External Printer (cont.)

Measurements and Markings (M and C versions only)

To define the measurements and markings proceed as follows:

Measurements (M and C Options Only) External printer					
Entry Key Sequence			Printout		Confirm
ALT	9	3	5	Detailed table of measurement results omitted - however, the values of electrical axes, intervals, and heart rate are not suppressed.	Press STOP key
			6	Detailed table of measurement results is printed	
			7	Reference markings are omitted	
			8	Reference markings (beginning and end of P wave and QRS, and end of T wave) are added to the ECG average cycles	

Interpretation (C version only)

To print or suppress interpretation statements on the printout proceed as follows:

Interpretation (Interpretation Option Only) External printer					
Entry Key Sequence			Printout		Confirm
ALT	9	4	5	Interpretation is omitted	Press STOP key
			6	Interpretation is printed	

Confirm the selection by pressing the STOP key



Full details of the interpretation option are given in the SCHILLER ECG Measurement and Interpretation booklet (art. No. 2.510 179).



Automatic Mode (ECG) Settings

Interpretation Settings (C version only)

The interpretation settings enable the user to determine whether or not certain comments will be added to the interpretation statements on the ECG printout. Furthermore, the patient's age can be defined (<30 or >30) and if low or high sensitivity should be applied. Low sensitivity will suppress certain non-specific and less important ECG diagnosis; this may be advisable when carrying out ECGs for screening.

Interpretation Settings				
Entry Key Sequence		Setting	Confirm	
ALT	6	1	"Normal" / "Abnormal" is not printed	Press STOP key
		2	"Normal" / "Abnormal" is printed	
		3	"Unconfirmed report" is not printed	
		4	"Unconfirmed report" is printed	
		5	Patient age assumed to be < 30	
		6	Patient age assumed to be > 30	
		7	Low sensitivity	
		8	High sensitivity	



Automatic Mode (ECG) Settings (cont.)

Selecting Rhythm Leads

The rhythm leads are printed out as defined. Two separate rhythm leads can be selected. The following formats can be set:

Rhythm Leads (interpretation option only)		
Entry Key Sequence		Setup Format
ALT	3	Define rhythm lead one
	4	Define rhythm lead two

The 2 rhythm leads are defined as follows:

Extremity Leads					
Entry Key Sequence			Lead	Confirm	
ALT	3 or 4	8	1	I	Press STOP key
			2	II	
			3	III	
			4	aVR	
			5	aVL	
			6	aVF	

Precordial Leads					
Entry Key Sequence			Lead	Confirm	
ALT	3 or 4	9	1	V1	Press STOP key
			2	V2	
			3	V3	
			4	V4	
			5	V5	
			6	V6	

Confirm the selection by pressing the STOP key



Service Printout

The service printout provides information about the patient cable and electrodes and gives the values of certain reference voltages and important internal offset values. These values are for information only. To obtain the service printout press

ALT - 0 - 3 - 3

```

*****SERVICE PRINTOUT*****

ECG AMPLIFIER:      U el (mV)
Uref+:  2001        R      0
Uref-:  2000        L      1
Udif:   4002        C1     0
Uoff:   112         C2     1
Calib:  1000        C3     0
                               C4     1
                               C5     0
                               C6     2

TPH TEMP:           22°

CHECKSUM:           GA48
    
```

- ECG Reference Voltage** This provides measurements and setting facilities for the reference voltage used for accurate measurement of ECG signals
- Uref + This gives the value of the reference voltage used in the multiplexer circuit on the ECG Amplifier. The value of the reference voltage is 2000 mV ± 20 mV.
 - Uref - This is a negative reference voltage used on the ECG Amplifier board. The value of this voltage should be -2000 mV ± 20 mV.
 - Udif This is the sum of the two reference values above (Uref+ and Uref-). This value must be 4000 mV ± 20 mV.
 - Uoff This is the value of the offset voltage on the multiplexer circuit. This value should be between + 150mV and - 150mV.
 - Calib This value is the Udif value divided by 4. The nominal value is 1000 ± 5 mV.
- Electrode dc offset** This gives the voltage drop in the patient cable and can indicate any faults in the patient cable or patient electrode. The value given is the dc voltage between the left leg electrode and all other electrodes. The measurements obtained will indicate any cable short circuits or open circuits. The measured voltage value will depend on where the electrodes are connected. The voltage readings that can be expected are as follows:
- With patient connected: ± 100mV
 - With patient simulator connected: ± 20 mV. This will depend on the patient simulator used and must be taken as a flexible measurement.
 - With all electrodes shorted together: ± 20 mV
 - No patient cable connected: -350 to -450mV
- TPH TEMP** This is the measured ambient temperature that the processor uses to correct print quality. This reading should be ambient temperature ± 5°.
- EPROM** This is the checksum for the EPROM. Its value varies from one software version to another.



Installing Software Options

To upgrade the AT-1 / AT-1 smartprint, for example from standard to M version, type the following:

ALT - 0 - 4 - followed by the upgrade code (obtainable from SCHILLER).

Acceptance of the code is indicated by a series of beeps.

CAUTION

MORE THAN 10 UNSUCCESSFUL ATTEMPTS TO ENTER THE CODE BLOCKS THE UNIT.



Care & Maintenance

12 Monthly Check

The unit should undergo a technical safety check every 12 months. This safety check should include the following:

- Visual inspection of the unit and cables.
- Electrical safety tests according to IEC 601-1 Clause 19.
- Functional tests according to Chapter 3.

The test results must be documented.

Cleaning the Casing

CAUTION

SWITCH THE UNIT OFF BEFORE CLEANING AND DISCONNECT THE MAINS AND THE EXTERNAL PRINTER (IF PRESENT). DO NOT, UNDER ANY CIRCUMSTANCES, IMMERSE THE APPARATUS INTO A CLEANING LIQUID OR STERILIZE WITH HOT WATER, STEAM, OR AIR.

The casing of the AT-1 / AT-1smartprint can be cleaned with a soft damp cloth on the surface only. Where necessary a domestic non-caustic cleaner can be used for grease and finger marks.

Patient Cable

CAUTION

ALIGN THE LEADS IN SUCH A WAY AS TO PREVENT ANYONE STUMBLING OVER THEM OR ANY DAMAGE CAUSED BY THE WHEELS OF INSTRUMENT TROLLEYS. THE SAME CAUTION APPLIES TO THE STORAGE OF THE LEADS.

The patient cable should not be exposed to excessive mechanical stress. Whenever disconnecting the leads, hold the plugs and not the cables.

The cable can be wiped with soapy water. Sterilization, if required, should be done with gas only and not with steam. To disinfect, wipe the cable with hospital standard disinfectant.

Cleaning the Thermal Printhead of the internal printer

If the printer is used a lot, a residue of printers ink (from the grid on the paper) can build up on the printhead. This can cause the print quality to deteriorate. We recommend therefore that every month the printhead is cleaned with alcohol as follows:

Remove the paper tray. The thermal printhead is found under the paper tray release catch. With a tissue dampened in alcohol, gently rub the printhead to remove the ink residue. If the printhead is badly soiled, the colour of the paper grid ink (i.e. red or green) will show on the tissue.



Replacing the Recording Paper in the Internal Printer

The recording paper must be replaced as soon as the end of the paper is indicated by a red stripe on the lower edge. After the indication first appears, there are about 8 pages left. However, we recommend that the paper be replaced immediately. If no paper is left, the printing process is interrupted and the paper warning lamp starts to blink. To replace the paper proceed as follows:

- Press the latch for the paper tray to release the lid with the rubber roller.

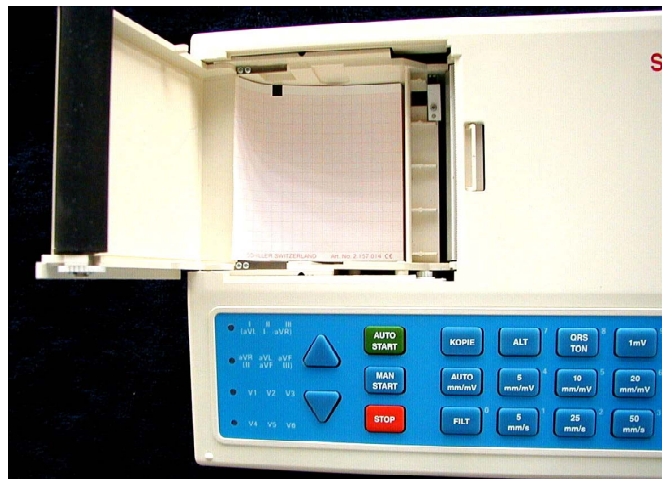
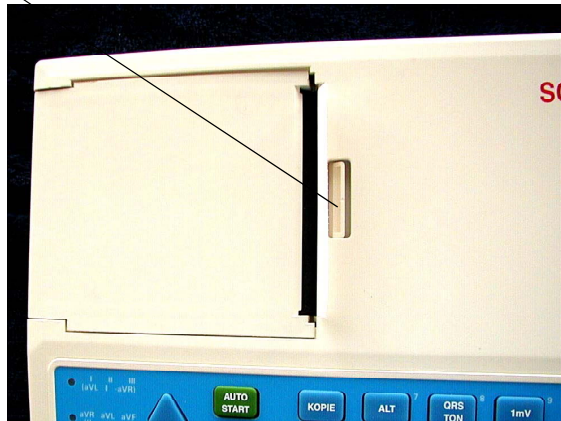

- Remove any remaining paper from the paper tray.
- Place a new paper pack into the paper tray with the printed (grid) side facing upwards.
- Close the lid and press firmly until release catches. Press the STOP key to transport the paper to the start position.

SCHILLER can only guarantee perfect printouts when SCHILLER original chart paper or chart paper of the same quality is used.



Thermal Paper Handling

The thermal paper used in the AT-1 / AT-1smartprint requires slightly different handling to normal paper as it can react with chemicals and to heat. However, when the following points are remembered, the paper will give reliable results:

The following points apply to both storage and when archiving the results.

1. Before use, keep the paper in its original cardboard cover. Do not remove the cardboard cover until the paper is to be used.
2. Store in a cool, dark and dry area.
3. Do not store near chemicals e.g. sterilisation liquids.
4. In particular do not store in a plastic cover.
5. Certain glues can react with the paper - do not attach the printout onto a mounting sheet with glue.



Chapter 2

Functional Overview



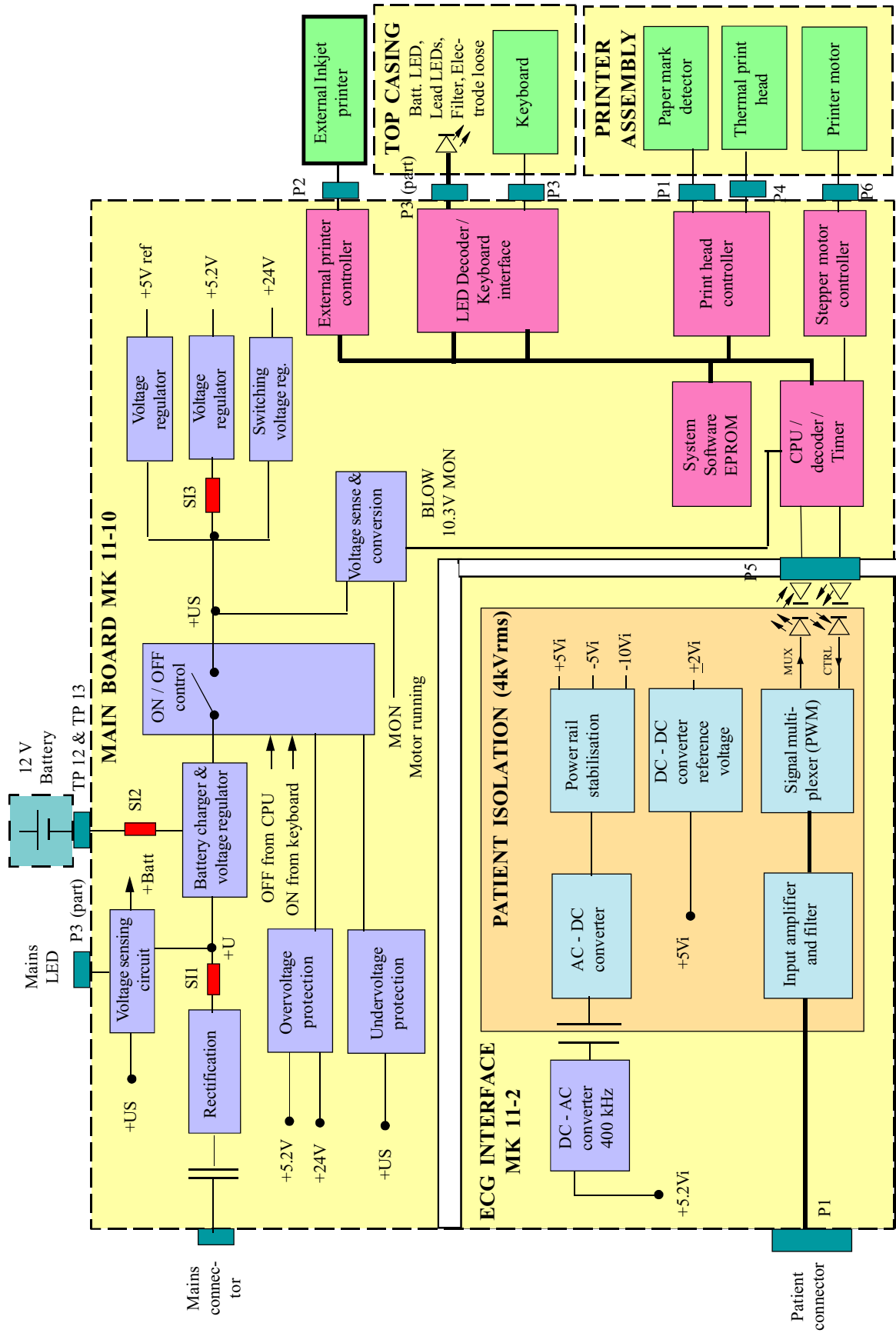

Introduction

This chapter provides a functional overview of the AT-1 / AT-1smartprint electronics. The aim of this overview is to enable the service engineer to identify processing paths in order to help identify possible faulty modules. A functional block diagram supports the text.



Main Board MK 11-10

Power Supply

The mains supply is full wave rectified to produce an unregulated dc supply of approximately 35 V (+U). This voltage is used by a switched voltage generator to produce +UD (13.5V). +UD charges the battery when mains is connected. When mains is not connected, +UD is the battery voltage.

An ON/OFF control logic switches +UD to three voltage regulators. The unit is switched on directly from the keyboard and then held on from the CPU. Detection of overvoltage on either the 5.2 V or 24 V supplies directly switches the unit off. Similarly when an undervoltage is detected on +US (indicating overcurrent) the unit is directly switched off.

The mains LED is lit directly when mains is connected. The same circuit also monitors the switched dc supply (+US) and activates signal +BATT when the unit is switched on and mains is not connected (i.e. the unit is running on battery power).

A Battery low signal (BLOW) is set to logic 0 when battery voltage (+US) falls to 11.3 V. A circuit compensates for voltage drop when the printer stepper motor is active and the BLOW signal is active only at 10.3 V.

Note : The battery voltage is also monitored directly by the CPU which switches the unit off when the voltage falls below approximately 9.4 V.

CPU and processing circuits

Overall control and coordination of the AT-1 / AT-1smartprint is performed by a Motorola 68332 Microcontroller, which performs all timing and control functions.

Memory

- An EPROM with 128 kByte memory contains the unit software.
- A static RAM memory stores the ECG data and comprises two 256 kByte RAM chips.
- A serial EEPROM (U48) stores the unit base settings.

Thermal Printhead Controller

The thermal printhead is controlled by a printhead controller and a CPU timer circuit. The printhead controller serialises the data for the printhead and the timer circuit controls how long current is applied to the head, and thus the intensity of the printout.

Printer Timing

Strobe generation is controlled by the CPU when one complete pixel line of data is ready to be written. Pulse length of STRB1 and STRB2 (each of which controls half of the pixel array) depends on the TPH temperature and therefore on the pulse width of the TPHT signal.

Note: TPH temperature reading is described on page 34.



Main Board MK 11-10 (cont.)

Paper Mark

The pulsed paper mark signal from the printer is fed to a comparator. A detected paper mark suppresses any (logic 0) pulses of PMARK at the output of comparator U38.

Power On Reset

The Power on reset circuit controls the master reset of the CPU. This circuit has two functions as follows:

- To provide a delay on initial switch-on to ensure that the power supply is fully stabilized and give the 200ms reset time required by the 68332 processor.
- To disable the unit if the +5V rail drops below +4.75V.

Stepper Motor Controller

The printer stepper motor controller sets the speed of the printer motor with a clock frequency dictated by the master CPU.

The purpose of the stepper motor controller circuit is to ensure that the motor speed requested by the microprocessor is achieved and maintained.

ECG Isolated Power Supplies

DC/DC converter circuits produce all the isolated power voltages required by the ECG Amplifier circuit.

The -2.0Vi and the 2Vi isolated reference voltages are generated from the -5Vi supply.

Note: When taking measurements always ensure that the isolated ground is used for reference.

ECG Signal

The incoming ECG signals RA, LA, and C1 to C6 are low-pass filtered (approximately 10kHz) and applied to non-inverting operational amplifiers giving a gain of 11. The signals are further low pass filtered (approximately 400Hz) and amplified by 23 before being applied to the multiplexer.

The multiplexer sampling rate is 1000Hz.

Noise Damping

The right leg electrode to the patient is the signal ground reference signal. To assist in cancelling some patient noise and thus reducing incoming signal distortion, the incoming signal from the patient left leg electrode is phase shifted 180°. This phase shifted signal is then used by the signal ground reference to cancel (or reduce) patient induced noise.





Chapter 3

Fault Diagnosis



Fault Diagnosis Chart

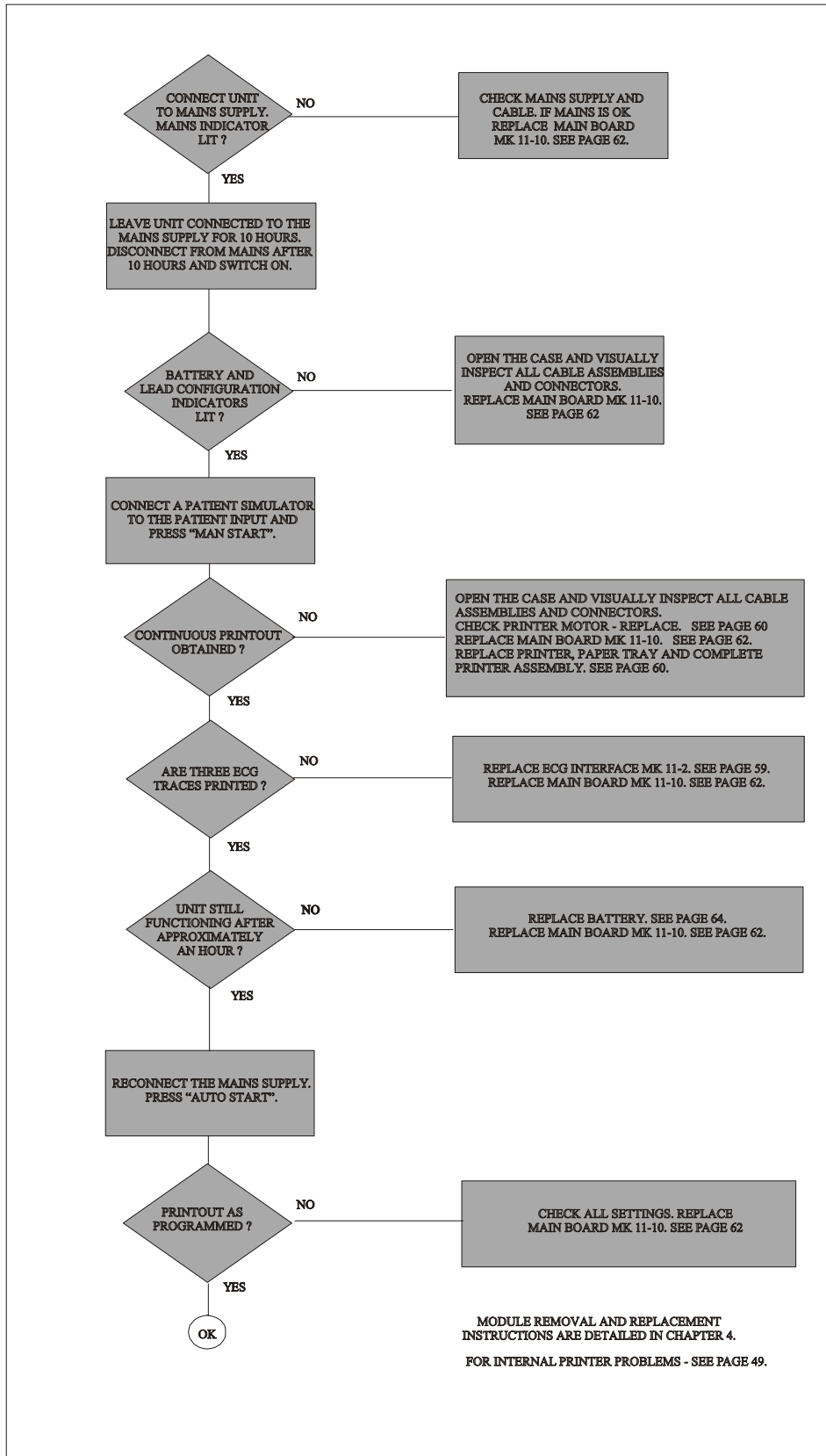

Introduction

The AT-1 / AT-1smartprint is designed for easy use and service: the service philosophy of the AT-1 / AT-1smartprint is module replacement and not board repair. The purpose of this chapter is to provide fault-finding procedures that will quickly and efficiently identify a fault to a specific module. Fault-finding procedures are designed so that test equipment is kept to a minimum.

An initial fault diagnosis chart is provided detailing general fault indications. Use the procedures on the following pages to indicate a faulty area or module. In most cases the fault diagnosis chart should indicate the most likely faulty area. When more than one module is stated, the first module given is the one most likely to contain the fault. Other modules given should be checked in the order given. When a module has been replaced, specific test parameters and setting-up of the module may be applicable. The removal and replacement instructions for all replaceable modules, along with any setup or check procedures required, are given in Chapters 4 and 5.





If the initial fault diagnosis chart does not indicate the area where the fault exists, re-check all the settings and parameters that have been entered.



General Functional Check Procedure

The procedure detailed here is a general confidence check of the unit after an internal module or board has been replaced. It is not a full functional test (which can only be carried out with dedicated equipment in the factory) but is intended to provide a general confidence check in all the major AT-1 / AT-1smartprint functional areas. The instructions given here are guides to the basic functions. If more operating information is required (general settings, comprehensive menu guides etc.) please refer to Chapter 1 in this publication or the relevant User Manual.

To carry out the general AT-1 / AT-1smartprint functional check procedure, proceed as follows:

1. Connect mains power to the unit and ensure that the green mains LED lights.
2. Switch the unit on by pressing the  key on the keyboard. Ensure that the LED lights flash for about a second.
3. Carry out the printer check detailed on the next page.
4. Connect an ECG simulator to the ECG connector on the side panel and switch on.
5. Press the  key and ensure that three leads are printed and are of good quality.
6. Press the  key and wait approximately 10 seconds for the printout to commence. Ensure that the printout is accurate and of good quality.
7. Switch the unit off  and leave connected to the mains supply for 10 hours or more to charge the battery.
8. Disconnect the mains and switch the unit on. Ensure that the Battery LED is lit. Run the unit on battery power for approximately one hour. Ensure that the battery LED flashes when the battery has limited capacity (not before 4 hours).



Internal Printer Check

To check the printer and to ensure that every pixel is operational, a built-in printer test is provided. To carry out the printer check press:

ALT - MAN START

A test printout is given. Four test patterns are available - toggle between the test patterns with the lead arrow keys up or down.  

Carefully examine the printout and ensure that all the lines are even and uninterrupted. Any faulty printhead pixels will be seen as a horizontal white line. Examine the printout for evenness of print.

If a faulty pixel is detected, the printer must be replaced. If the printout is uneven (for example darker at the top than at the bottom), it indicates that the printer alignment is not correct. If the printout is too faint or too dark, check the TPH temperature in the service printout given in Chapter 5. Also check the paper; old paper, paper that has been exposed to light for a long period, or poor quality paper can all adversely effect the print quality.

NOTE: THE 'SHELF LIFE' OF THE PRINTER PAPER IS NOT INDEFINITE. OLD PAPER, PAPER THAT HAS NOT BEEN STORED IN A COOL DAMP-FREE ENVIRONMENT, OR PAPER THAT HAS BEEN EXPOSED TO EXCESSIVE HEAT CAN ADVERSELY EFFECT THE QUALITY OF THE PRINT

Printhead Alignment and Printhead Tension

The printhead tension (the pressure that the printhead exerts on the printer paper) is achieved with two springs exerting pressure on the printhead: the printhead tension cannot be adjusted. Similarly, printhead alignment is fixed and cannot be adjusted. If the printhead tension or printhead alignment is not correct, change the paper tray and printer assembly.

Possible Printer Problem Internal Thermoprinter	Corrective Action
Paper jams or does not stop at correct position.	Clean paper mark detector with a 70% alcohol solution. (See page 60.) Allow to dry completely. Ensure that good quality, fresh paper is installed. Change the Printer Motor, see page 60-61.
Printout uneven; Fading at top or bottom.	Check evenness of spring pressure of the printer to roller by pulling a sheet of paper through. Check roller for wear and symmetry. Clean printhead (pixel array) with alcohol. Ensure that good quality, fresh paper is installed.
Faulty pixel.	Clean printhead (pixel array) with alcohol. Replace printer.
Printout too faint or too dark; General quality poor.	Clean printhead (pixel array) with alcohol. Ensure that good quality fresh paper is installed.



Printer Check

External Printer Problems

Possible Printer Problem External Inkjet printer	Corrective Action
No printout	Check that the USB and the Centronics interface on the external printer are not simultaneously engaged.
Poor quality printout.	Make sure that the printer and the AT-1 smartprint are properly grounded via the potential equalisation stud.
No printout	No format has been selected in Settings. Select a proper format.



Chapter 4

Module Removal and Replacement



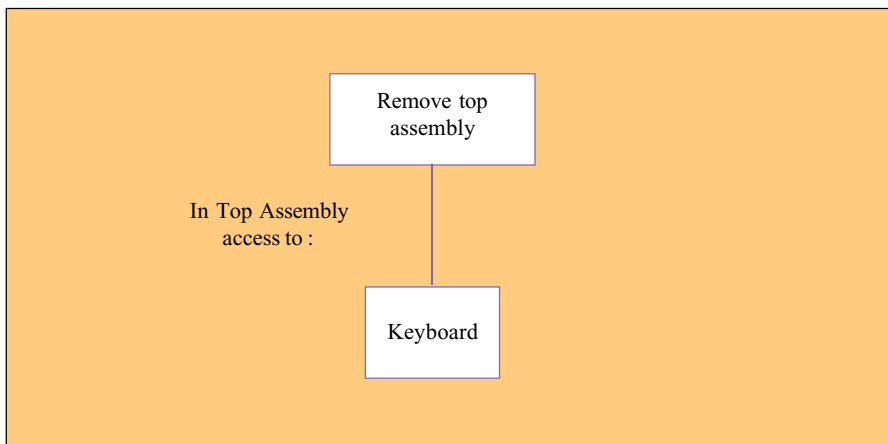
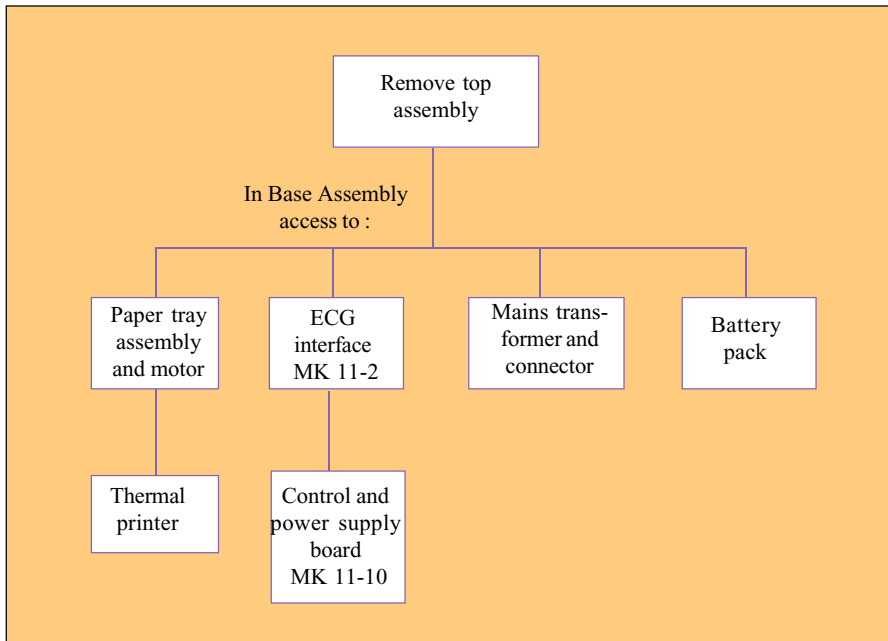

Introduction

This chapter provides an overview of the procedures to remove and replace the modules that are spared at service level. The instructions given in this chapter are autonomous, with each module containing the following:

- The prerequisites that must be fulfilled before removing the module
- Tools and equipment that are required to remove and replace the module and to carry out the functional checks and adjustments
- Removal procedures
- Replacement procedures
- Checks and tests that must be carried out after replacement.

Any adjustments, special checks or functional procedures that are required during a procedure are detailed in the relevant step.

In-text diagrams support the text where required and provide location details of connectors, test points and adjustment potentiometers.

Specific warnings and cautions are given where applicable. Warnings indicate potential danger that could cause personal injury. Cautions indicate areas that could cause damage to the equipment.

If a key operation or menu selection is required, the key sequence required is given in bold letters. The character (or character string) given is the actual character that is printed on the key. When a key sequence is provided it must be followed in the order given.



Warnings and Cautions

WARNINGS

BEFORE COMMENCING ANY REMOVAL OR REPLACEMENT PROCEDURES ENSURE THAT THE MAINS POWER SUPPLY IS SWITCHED OFF AND THAT THE MAINS CABLE IS REMOVED.

CERTAIN CHECKS AND ADJUSTMENTS CAN ONLY BE CARRIED OUT WITH THE TOP ASSEMBLY REMOVED AND WITH MAINS CONNECTED. WHEN CARRYING OUT THESE PROCEDURES BEWARE THAT POTENTIALLY LETHAL VOLTAGES ARE PRESENT.

CAUTIONS

THE AT-1 / AT-1SMARTPRINT CONTAINS STATIC SENSITIVE CMOS COMPONENTS, OBSERVE ANTISTATIC PRECAUTIONS.

WHEN CARRYING OUT ANY MAINTENANCE PROCEDURES ALWAYS PLACE THE UNIT ON AN EARTHED ANTISTATIC MAT.

PERSONNEL MUST BE EARTHED WHEN HANDLING ANY BOARDS OR COMPONENTS

ALWAYS USE AN ANTISTATIC BAG WHEN TRANSPORTING BOARDS OR COMPONENTS

THE UNIT IS SUSCEPTIBLE TO ABRASION DAMAGE. TO PREVENT SCRATCHING, ALWAYS PLACE THE UNIT ON A SOFT, NON-ABRASIVE CLOTH WHEN CARRYING OUT MAINTENANCE PROCEDURES.

TAKE CARE NOT TO PLACE ANY STRAIN ON THE CONNECTING RIBBON CABLE WHEN REMOVING THE TOP HOUSING. ENSURE THAT THE CABLE ASSEMBLY IS NOT CRIMPED OR TWISTED AND THAT THE TOP HOUSING IS NOT PLACED ON THE CABLE ASSEMBLY.

CARE MUST BE TAKEN WHEN REMOVING AND REPLACING CONNECTORS. NEVER USE FORCE. NEVER STRAIN THE CABLE ASSEMBLIES.

THE PROCEDURAL STEPS GIVEN FOR EACH MODULE MUST BE FOLLOWED IN THE ORDER GIVEN.



Physical Overview

The AT-1 / AT-1smartprint unit is enclosed in a two part, medical standard, moulded plastic case.

The top housing contains the keyboard with the base assembly containing all the electronics of the unit, the thermal printer, the paper tray, the battery and mains transformer.

The electronics of the unit are contained on two printed circuit boards (control and power supply board MK 11-10 and the ECG interface board MK 11-2). The ECG interface board also supports the patient connector. The PCBs are secured on spacers moulded in the base section.

The battery is secured in position with double sided tape and the mains transformer is secured on spacers.

The thermal printer is mounted on a printer / paper tray assembly which is secured in the base assembly.

Because of the plastic construction of the case, threaded metal inserts are used throughout for all screw fixings.

Test Equipment, Tools, and Accessories

The following list details the tools, test equipment and accessories required to carry out all functional tests, calibration procedures and adjustments that can be carried out on the AT-1 / AT-1smartprint. The test equipment given here is general. If specific recommendation for test equipment is required, please contact the SCHILLER service department.

- Selection of posi-drive and flat-bladed screwdrivers
- Cleaning agent such as Trichlorethylene
- Double-sided tape
- ECG Patient Simulator
- SCHILLER 10 lead patient cable Number 2.400070 (2.400071 for USA)
- Spring compressor, if available, or a pair of pliers



Opening the Case

Prerequisites

- The unit must be placed on an antistatic mat and antistatic precautions observed when any maintenance is carried out on the AT-1 / AT-1smartprint. The room temperature should be between 18 and 28 °C.
- THE WARNINGS AND CAUTIONS AT THE BEGINNING OF THE CHAPTER MUST BE OBSERVED.

Tools

- Posi-drive screwdriver

Test Equipment

The following test equipment is required to carry out the functional test after unit assembly

- SCHILLER Patient Cable
- Patient Simulator e.g. phantom 320.

Top Housing Removal

The Top Housing is mounted on the Base Assembly and is secured to the Base Assembly with six screws; access to the screws is gained from the underside of the unit. To remove the Top Housing, proceed as follows

WARNING

ENSURE THAT THE MAINS CABLE IS REMOVED !

1. Turn the unit upside-down and rest on a soft antistatic cloth.
2. Unscrew and remove the six countersunk retaining screws and washers situated in the extreme corners and edges of the unit.
3. Grasping the top housing and base assembly to ensure that they cannot part, carefully return the unit to the standing position.
4. Release the catch and open the paper tray lid with the printer roller.
5. Gently lift the Top Housing and turn it slightly counter-clockwise so it can be lifted away from the paper tray lid.
6. Disconnect the cable assembly between the control and power supply board MK 11-10 and the keyboard.
7. Gently lift the Top Housing away from the Base Assembly and place it on a soft cloth.



Top Housing Replacement

To replace the Top Housing proceed as follows:

1. Check that all boards and components are firmly secured. Check for loose screws. Ensure that no screws or foreign bodies are loose in the bottom of the case.
2. Inspect all the internal cable assemblies and ensure that they are in good condition and that no visible damage can be seen. Ensure that no cable assemblies are strained, crushed or caught.
3. Ensure that all connectors are firmly home.
4. Position the Top Housing in front of the Base Assembly and, without straining the ribbon cable, plug in the interconnecting cable from the keyboard to the main board MK 11-10. See picture next page.

Note: It may be necessary to tilt the Top Housing for the cable assemblies to reach.

5. Turn the Top Housing slightly counter-clockwise and lift it over the paper tray lid.
6. Carefully position the Top Housing on the Base Assembly and close the paper tray lid.
7. Grasping the Top Housing and the Base Assembly to ensure that they cannot part, carefully turn the unit upside-down and replace the six securing screws and washers in the extreme corners and edges of the unit. Return the unit to the upright position.
8. Carry out the functional check procedure detailed in Chapter 3.

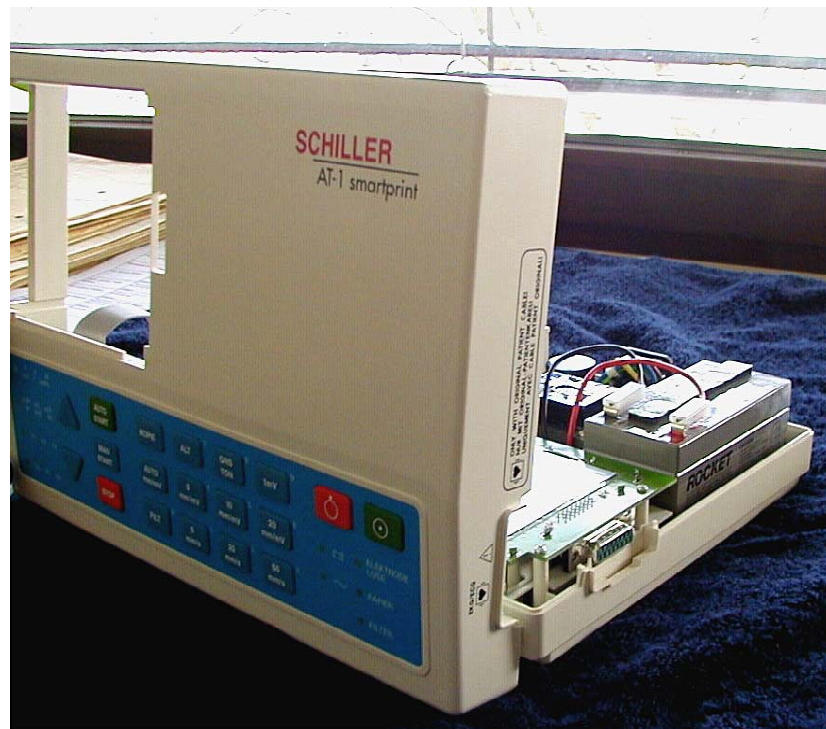

Physical Overview

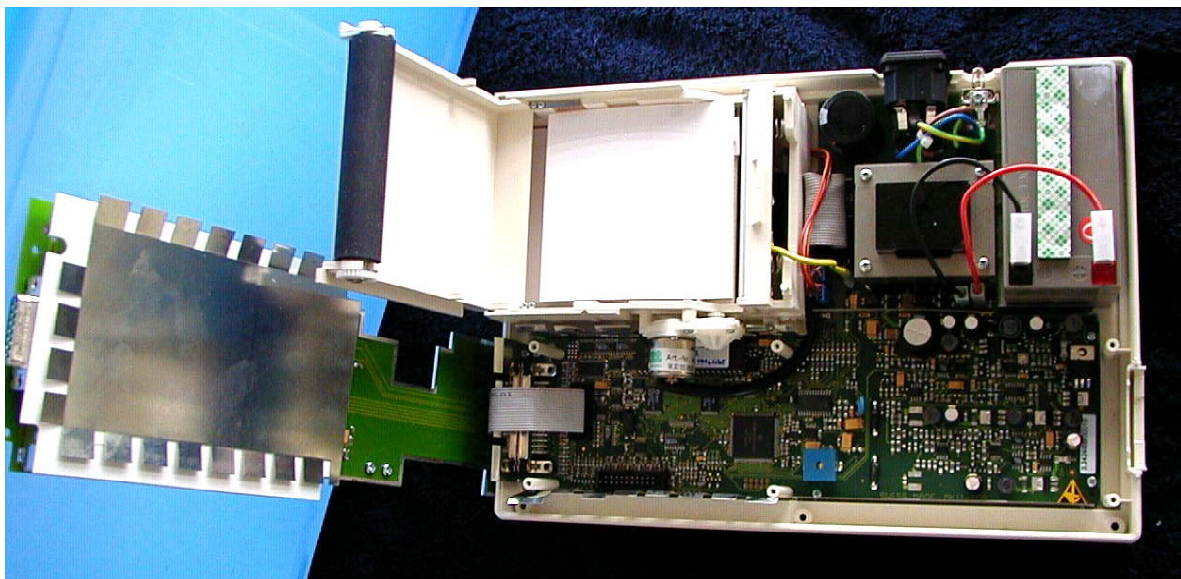
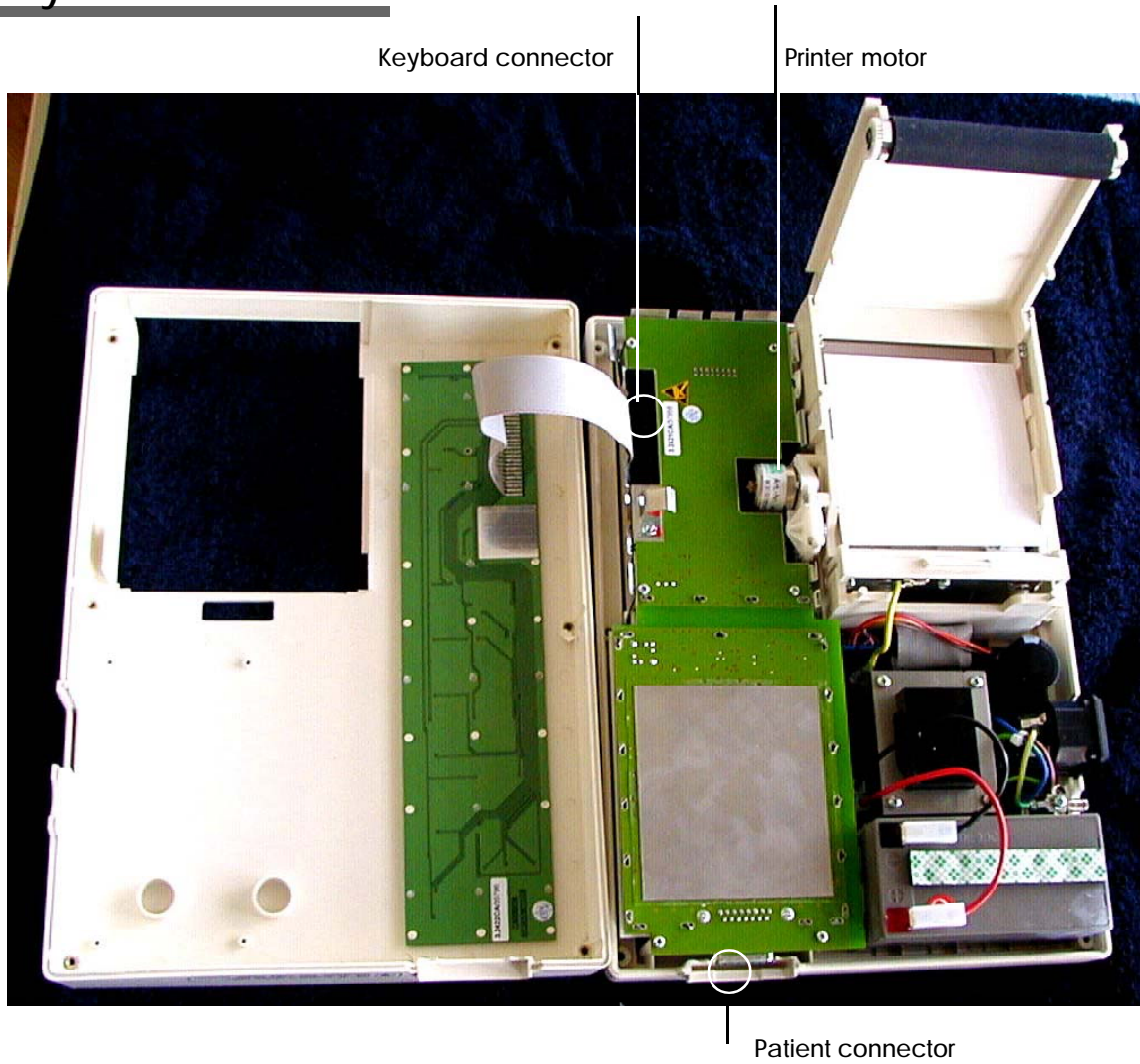

View of the unit with the ECG interface board lifted up.



ECG Interface Board MK 11-2

The ECG Interface is mounted above the Control and Power Supply board MK-11-10 and is secured to six spacers.

Prerequisites

- The Warnings and Cautions at the beginning of the Chapter must be observed.
- The top housing must be removed as detailed on page 56. All external cable assemblies must be disconnected.

Tools

- Posi-drive screwdriver

Part Numbers

The part number for the ECG Interface Board is given in Chapter 6.

Board Removal

CAUTION

THE ECG INTERFACE CONTAINS STATIC SENSITIVE CMOS COMPONENTS. OBSERVE ANTISTATIC PRECAUTIONS.

To remove the ECG interface proceed as follows:

1. Unscrew the six screws securing the board to the spacers.
2. Gently raise the board to gain access to the cable assembly to the Control Board MK 11-10 and remove the connector. Remove the board.

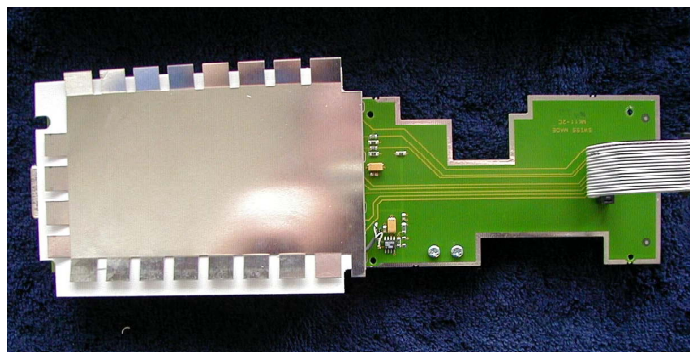

Board Replacement

1. Connect the cable assembly to the Control Board MK 11-10. Place the ECG amplifier board component-side down over the six spacers so that the patient cable connector is positioned in the cutout on the side panel.
2. Secure the board to the six spacer supports with the retaining screws.
3. Replace the Top Housing as explained on page 57

Checks and Tests after Replacement

To prove the integrity of the replaced board carry out the following functional check procedure:

Switch on the unit and connect a SCHILLER patient cable to the ECG connector. Connect a suitable patient simulator to the ECG connector and press MAN START. Ensure that all the leads are printed.

Printer Tray Assembly and Thermal Printer

Prerequisites

- The Warnings and Cautions at the beginning of the Chapter must be observed.
- The top housing must be removed as detailed previously. All external cable assemblies must be disconnected.

Tools

- Posi-drive screwdriver
- Spring compressor or pliers

Part Numbers

The part numbers for the Thermal Printer Assembly, the printhead and the motor are given in Chapter 6.

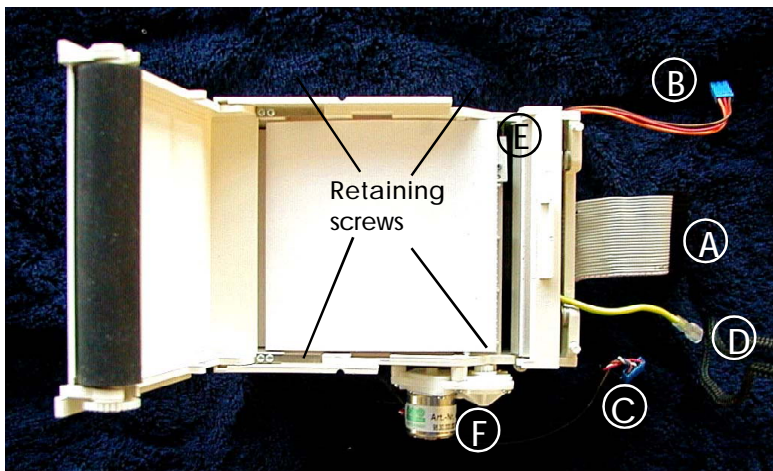

E = Paper mark detector

F = Printer motor

CAUTION

THE THERMAL PRINTER CONTAINS STATIC SENSITIVE COMPONENTS. OBSERVE ANTISTATIC PRECAUTIONS.

Printer / Paper Tray Assembly Removal

1. Remove the following connectors from the Control and Power Supply Board MK 11-10:
 - data connector to the thermal printer (A)
 - paper mark connector (B)
 - printer motor connector (C)
 - earth connector to the printhead (D)
2. Unscrew the four retaining screws and remove the complete paper tray / printer assembly.

Printer/Paper Tray Assembly Replacement

1. Position and secure the assembly in the base with the four retaining screws.
2. Reconnect the following connectors to the Control and Power Supply Board MK 11-10:
 - data connector to the thermal printer (A)
 - paper mark connector (B)
 - printer motor connector (C)
 - earth connector (D)
3. Replace the Top Housing, see page 57.



Thermal Printer Removal

1. Remove the top housing and the printer tray assembly as outlined above.
2. Turn the printer / paper tray assembly upside-down and unscrew the two printer retaining screws.

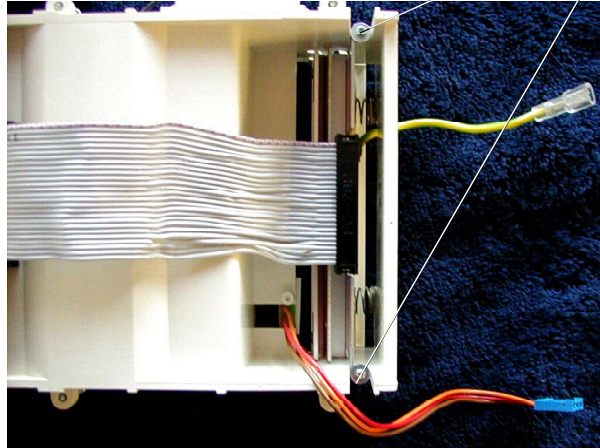

3. Gently remove the printhead taking care to retain the two tensioning screws.

Thermal Printer Replacement.

To replace the thermal printer proceed as follows:

1. Position the printer in the printer / paper tray assembly so that the printer mounting plate lips slot into the dedicated cutouts in the assembly; secure with the two retaining screws. Ensure that the cable assemblies from the printer to the interface PCB are not caught and are not strained.
2. Using a spring compressor or a pair of pliers, insert the two tensioning springs so that the springs are positioned over the outer two moulded spring supports and in the indent (hole) in the printer mounting plate
3. Replace the printer / paper tray assembly as described on page 60.
4. Replace the top housing as described on page 57.

Checks, Tests and Adjustments after Printer Replacement

Check the print quality as described in Chapter 3.

Printer Motor Removal and Replacement

1. Remove the top housing and the printer / paper tray assembly as outlined above.
2. Turn the printer / paper tray assembly on the side to get access to the printer motor.
3. Unscrew and remove the two fixing screws, and carefully lift the motor out of the assembly.
4. Replace the motor, carefully put it in place and fasten the two retaining screws.
5. Replace the printer / paper tray assembly and the top housing as explained above.

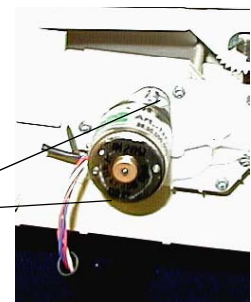

Control and Power Supply Board MK 11-10

The Control and Power Supply Board MK 11-10 is secured to the base assembly and located under the ECG Interface Board MK 11-2.

Prerequisites

- The Warnings and Cautions at the beginning of the chapter must be observed.
- The top housing must be removed and all external cable assemblies disconnected.
- The ECG Interface Board must be removed.
- The printer / paper tray assembly must be removed.

Tools and Equipment

Posi-drive screwdriver

Parts

Control and Power Supply board MK 11-10. Part number as detailed in Chapter 6.

Board Removal

WARNING

ENSURE THAT THE MAINS CABLE IS DISCONNECTED BEFORE COMMENCING

To remove the Control and Power Supply Board MK 11-10 proceed as follows:

1. Disconnect the following connectors:
 - live and neutral bayonet connectors to the mains connector
 - battery connectors

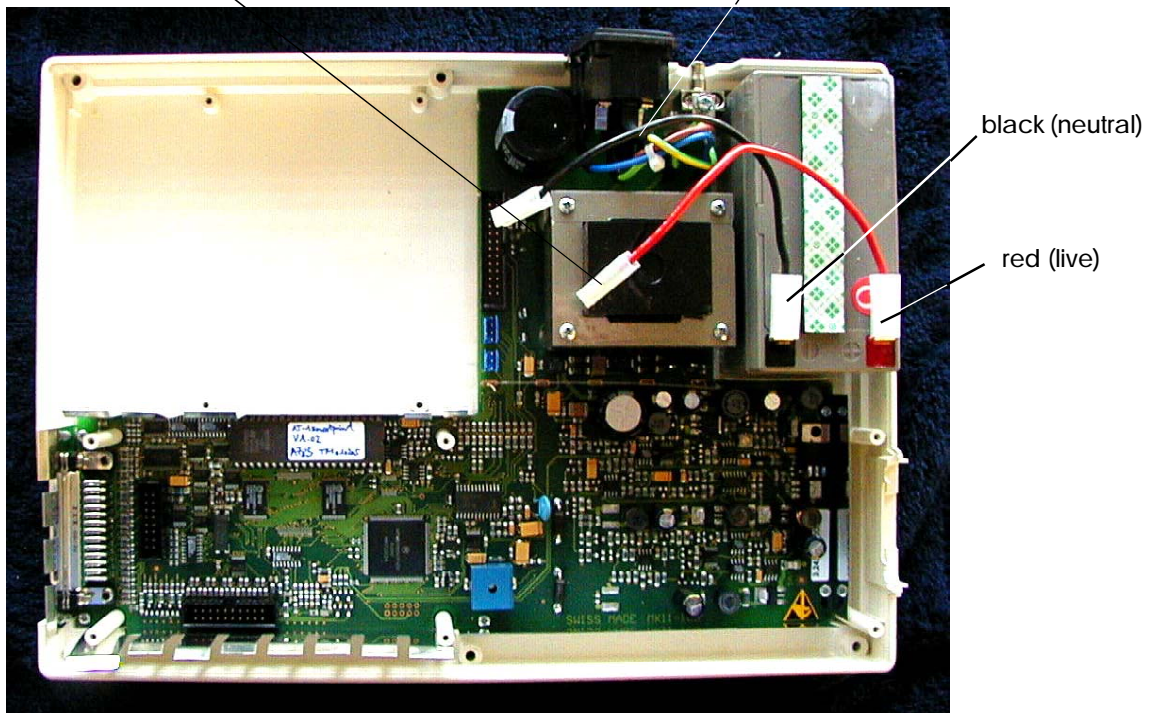

2. Unscrew the 12 fixing screws (four on the mains transformer) and lift out the board.



Control and Power Supply board MK 11-10

Board Replacement

To replace the Control and Power Supply Board MK 11-10 proceed as follows:

1. Position the board and secure at the 12 fixing points (four on the mains transformer)
2. Connect the following:
 - live and neutral bayonet connectors to the mains connector
 - live and neutral bayonet connectors to the battery

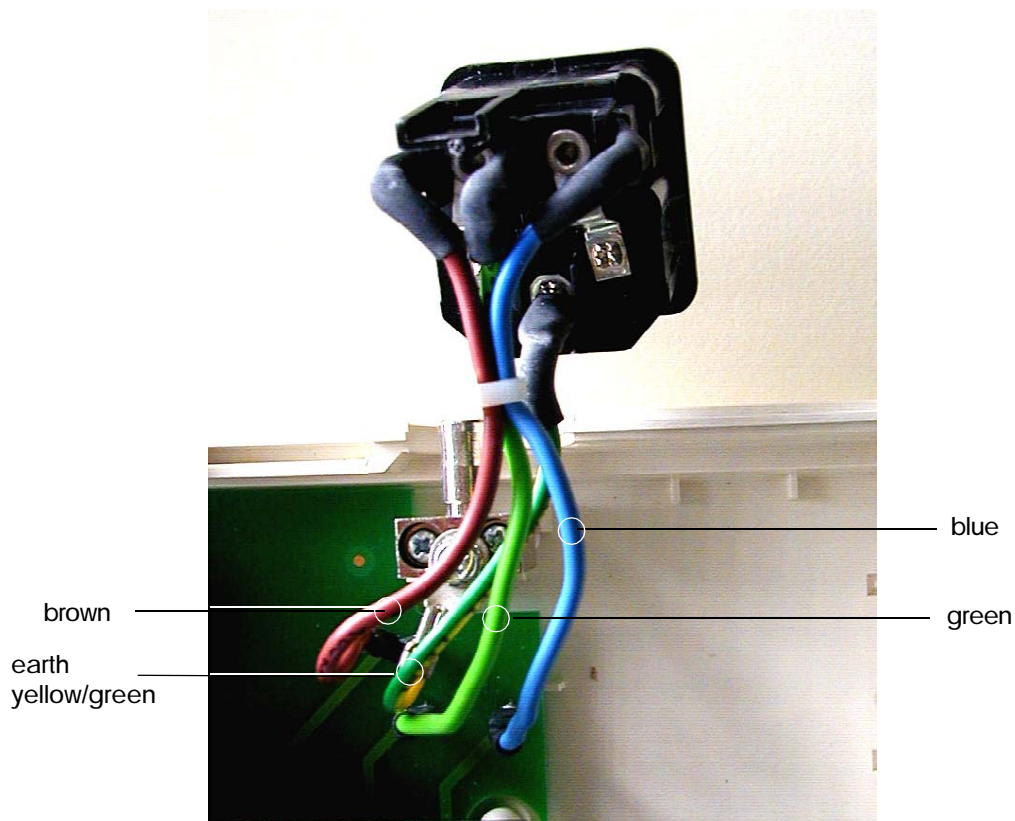

3. Replace the printer / paper tray assembly and connect all cables.
4. Replace the ECG interface board (see page 59).
5. Replace the top housing and reassemble the unit as described on page 57.

Battery Pack

The battery pack is held in position with double-sided tape.

Prerequisites

- The Warnings and Cautions at the beginning of the Chapter must be observed.
- The top housing must be removed and all external cable assemblies disconnected.

Tools and Equipment

Double-sided tape

Parts

The part numbers of all replaceable items are given in Chapter 6.

Battery Pack Removal

WARNING

THE MAINS SUPPLY MUST BE DISCONNECTED DURING THIS PROCEDURE

To remove the Battery Pack proceed as follows:

1. Ensure that the unit is switched off and that the mains is disconnected.
2. Disconnect the two bayonet connectors and remove the Battery Pack by gently pulling away from the base.

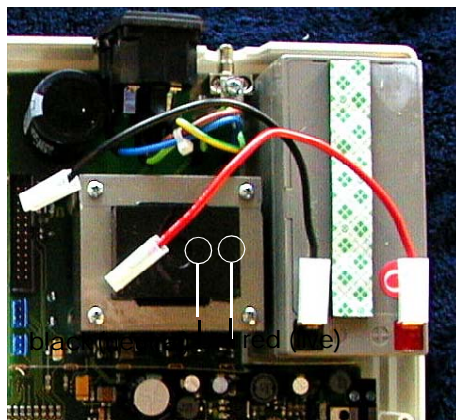

Battery Pack Replacement

1. Stick a piece of double-sided tape to the bottom of the battery pack.
2. Position the battery pack with the connectors towards the inside of the unit as shown above.
3. Press firmly on the battery, so the double-sided tape sticks to the base assembly.
4. Connect the bayonet connectors for the red and black lead as shown above.
5. Replace the top housing and reassemble the unit as described on page 57.



Battery Pack

Settings After Battery Replacement (AT-1 smartprint only)

Program all static settings which will have been lost when the battery was disconnected including date and time.

Set Date

ALT - 0 - 5 - 2 - D - D - M - M - Y - Y

An acoustic signal confirms the changed setting.

Set Time

ALT - 0 - 5 - 1 - H - H - M - M - S - S

An acoustic signal confirms the changed setting.

Note: If the battery has been disconnected for more than half an hour, the clock oscillator must be restarted before setting the time. To do this the following key sequence must be pressed:

ALT - 0 - 5 - 9

This will start the oscillator and the time can be set.

Note: The time and date only appear on the AUTO printout from the external printer.



Keyboard

The keyboard comes as a complete assembly with the top housing. The part number for the keyboard complete with top housing is given in Chapter 6.



Chapter 5

Adjustments



Introduction

This chapter provides the procedures necessary to check and adjust all service settings. Every procedure is self-contained and details the tools required to carry out adjustments, and the test equipment necessary. Any adjustments, special checks or functional tests that are required on the module, or on associated modules or software, are also detailed.

In-text illustrations support the text where required and provide location details of connectors, test points and adjustment potentiometers.

Specific warnings and cautions are given in the text where applicable.

The part numbers for all replaceable modules are given in Chapter 6.

The AT-1 / AT-1smartprint has the following adjustments:

- Battery Charge Voltage (VR4 on the control and power supply board MK 11-10)
- ECG Amplifier reference voltage and ramp slope (VR2 and VR3 on the ECG interface board MK 11-2)

We recommend that the reference voltages are checked every year.



Warnings, Cautions and Conditions

WARNING

MAINS POWER IS POTENTIALLY LETHAL - DISCONNECT THE MAINS BEFORE DISASSEMBLING THE UNIT. ADDITIONALLY ENSURE THAT THE MAINS IS DISCONNECTED BEFORE CARRYING OUT ANY MAINTENANCE, CALIBRATION, CHECKS OR ADJUSTMENTS.

CAUTIONS

THE AT-1 / AT-1 SMARTPRINT CONTAINS STATIC SENSITIVE CMOS COMPONENTS; OBSERVE ANTISTATIC PRECAUTIONS. WHEN CARRYING OUT ANY MAINTENANCE PROCEDURES ALWAYS PLACE THE UNIT ON AN EARTHED ANTISTATIC MAT. PERSONNEL MUST BE EARTHED WHEN HANDLING ANY BOARDS OR COMPONENTS. ALWAYS USE AN ANTISTATIC BAG WHEN TRANSPORTING BOARDS OR COMPONENTS

CARE MUST BE TAKEN WHEN REMOVING AND REPLACING CONNECTORS. NEVER USE FORCE. NEVER STRAIN THE CABLE ASSEMBLIES.

THE PROCEDURAL STEPS GIVEN FOR EACH MODULE MUST BE FOLLOWED IN THE ORDER GIVEN.

THE OUTER SURFACES OF THE AT-1 / AT-1 SMARTPRINT ARE SUSCEPTIBLE TO ABRASION DAMAGE. TO PREVENT SCRATCHING, ALWAYS PLACE ON A SOFT, NON-ABRASIVE CLOTH.

Conditions

The unit must be placed on an antistatic mat and antistatic precautions observed when any maintenance is carried out on the AT-1 / AT-1smartprint.

The room temperature should be between 18 and 28 °C.

Note: When a key operation or menu selection is required in the following procedures, the key sequence required is given in bold letters. The character, or character string, given is the actual character, or character string, printed on the key.



Test Equipment

The following proprietary and dedicated test equipment is required to fault find and carry out all board checks and adjustments on the AT-1 / AT-1smartprint.

The list of proprietary equipment is not comprehensive. Recommendations of suitable proprietary test equipment can be obtained from the SCHILLER Service Department.

Proprietary Test Equipment/Tools

- Digital Multimeter
- Standard tool kit with a selection of flat-bladed and posi-drive screwdrivers, pliers and general tools
- Resistor 2.7 kOhms, 250 mW



Battery Charge Voltage

Precautions and Requirements

The unit must be placed on an antistatic mat and antistatic precautions observed when any maintenance is carried out on the AT-1 / AT-1 smartprint. The room temperature should be between 18 and 28 °C.

Tools and Equipment

- Digital Multimeter
- Small flat bladed screwdriver
- Resistor 2.7 kOhms, 250 mW

Procedure

The battery charge voltage is nominally 13.5 V (with a nominal maximum current of approximately 5 mA). Adjust and check as follows:

- DISCONNECT THE MAINS SUPPLY !
- Disassemble the unit as detailed in Chapter 4 and remove the ECG interface board MK 11-2.
- Remove the two battery connectors and connect a 2.7 kOhm 250 mW resistor across the two connectors (TP12 and TP13) to simulate a discharged battery. Connect the digital multimeter across the resistor.
- Connect the mains supply.

WARNING

EXERCISE CARE - BEWARE THAT POTENTIALLY LETHAL VOLTAGES ARE PRESENT.

- Adjust VR4 to obtain a charging voltage of 13.5 V.
- Disconnect the mains supply and reassemble the unit as detailed in Chapter 4.

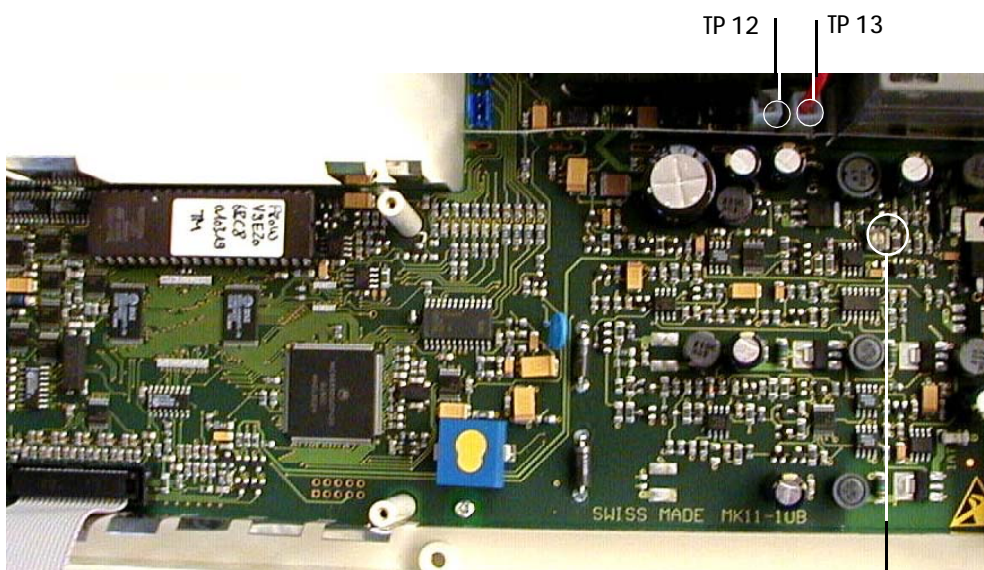

Battery Charge Voltage VR4

ECG Amplifier Reference Voltage

The +/- 2 V voltage rails generated on the ECG interface board are used as a reference by the measurement and the PWM (Pulse Width Modulation) circuits.

NOTE: The ECG board reference voltage is given on the service printout and can be checked without disassembling the unit. Full details of the service printout are given on page 34.

IMPORTANT

THE +/- 2 V REFERENCE VOLTAGES AND THE PWM RAMP MUST BOTH BE ADJUSTED AT THE SAME TIME.

Tools, Equipment and Material

- Digital multimeter
- Small flat bladed screwdriver

Procedure

- DISCONNECT THE MAINS SUPPLY !!
- Disassemble the unit as detailed in Chapter 4.
- Remove the screws securing the ECG interface board MK 11-2, remove the connecting cable to the control and power supply board, and gently lift up the ECG interface board.
- Use a pair of flat-bladed pliers to tweak the metal tabs of the ECG shield, which are protruding through the board, and turn them in such a way that the ECG shield can be removed. Remove the ECG shield.
- Carefully place the ECG interface board by the side of the unit with the component side up. Reconnect it to the control and power supply board.
- Reconnect the keyboard to the control and power supply board and place the top housing on its side in front of the base assembly as shown below.

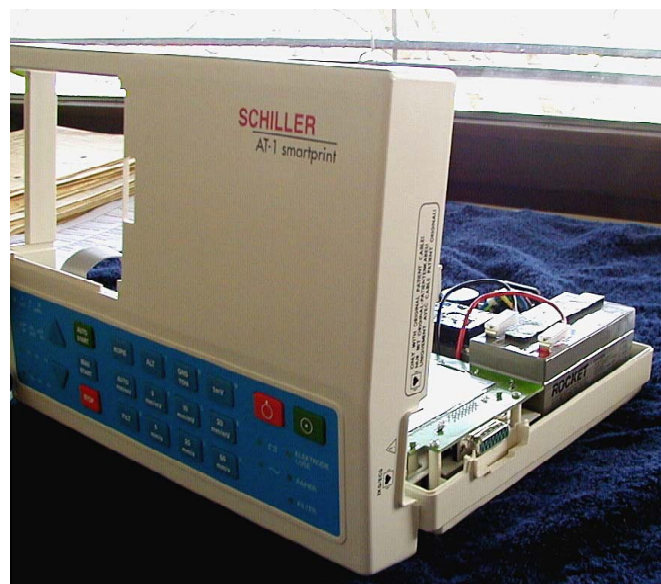

ECG Amplifier Reference Voltage

- Switch the unit on and measure the voltage difference between the +2 V reference and the -2 V reference on pins 1 and 7 of operational amplifier U100. Adjust the trimmer VR2 to achieve a voltage difference of 4000 mV +/- 2 mV.

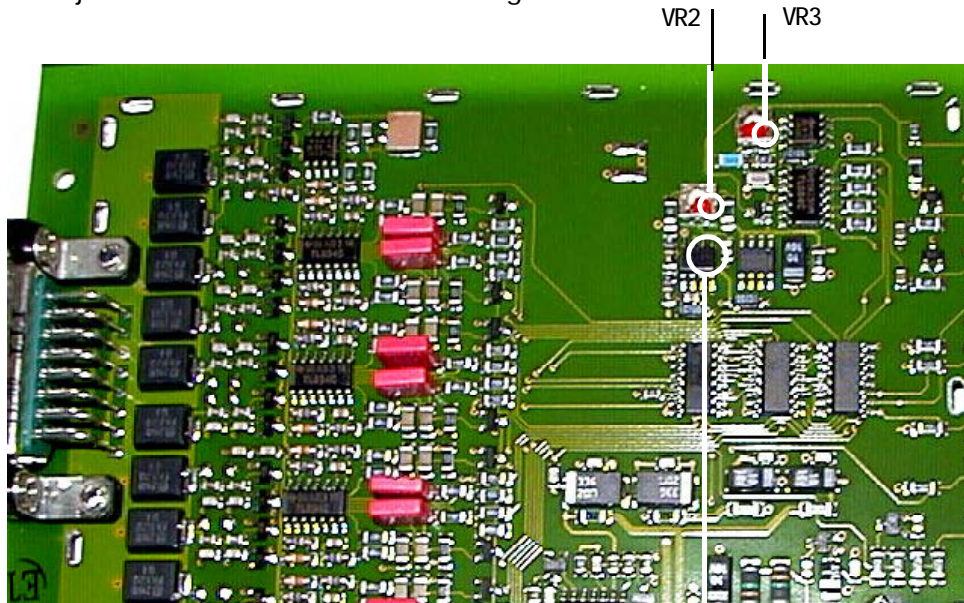

Oper. amp. U100
Pin 1 low/left

- Obtain a service printout by pressing

ALT - 0 - 3 - any key

```
*****SERVICE PRINTOUT*****  
  
ECG AMPLIFIER:      U el (mV)  
Uref+: 2001         R      0  
Uref- : 2000         L      1  
Udif: 4002          C:1    0  
Uoff: 112           C:2    1  
Calib: 1000         C:3    0  
                   C:4    1  
                   C:5    0  
                   C:6    2  
  
TPH TEMP:           22°  
  
CHECKSUM:           FA48
```

- Ensure that the Uref+ and the Uref- measurements are both 2000 mV +/- 20 mV. Ensure the the Udiff reading is 4000 mV. Adjust VR3 to achieve a Udiff reading of 4000 mV +/- 20 mV.
- Reassemble the unit as detailed in Chapter 4. Recheck the voltage by again obtaining a service printout.





Chapter 6

Spare Parts



Ordering Information

Your local representative stocks all the disposables and accessories available for the AT-1 / AT-1smartprint. In case of difficulty or to obtain the address of your local dealer, please contact the head office. Our staff will be pleased to help process your order or to provide any details for all SCHILLER products.

The address for advice is:

SCHILLER AG
Sales Department (Order Processing)
Altgasse 68
CH-6341 Baar
Switzerland

Phone Number: + (41) 41 766 42 42

Fax Number: + (41) 41 761 08 80

When ordering, state that the order is for an AT-1 / AT-1smartprint unit and provide the following:

- Part Description
- Part Number
- Your Address

Service Department

If you need help from our service engineers, please contact the following number:

Fax Number: + (41) 41 761 03 34

If you contact us by fax, be sure to provide the following information:

- Serial Number for your AT-1 / AT-1smartprint
- Software version for system, printer
- Accessories used, model and cable number



Spare Parts

DESCRIPTION	PART NUMBER
AT-1 Control and power supply board MK 11-1	3.2420
AT-1 smartprint Control and power supply board MK 11-10	3.2426
ECG amplifier board MK 11-2	3.2421
Paper mark sensor board MK 11-51	3.2423
AT-1 software (programmed EPROM)	4.999940
AT-1 Bottom assembly complete	3.910960
AT-1 smartprint Bottom assembly complete	3.910940
Top housing with keyboard complete (German)	3.910961
Top housing with keyboard complete (English)	3.910962
Top housing with keyboard complete (French)	3.910963
Top housing with keyboard complete (Spanish)	3.910964
Top housing with keyboard complete (Portoguese))	3.910965
Printer / Paper tray assembly complete	3.910966
Paper tray lid	3.910967
Ground shield	4.416028
Transformer shield	4.416027
ECG isolation shield	4.435198
Mains socket complete	4.270009
Mains fuse holder	4.210049
Mains fuse - 200 mA/T	4.210010
Mains transformer	4.320066
12 V lead acid battery	4.350024
Printer motor complete	4.330019
Thermal printhead	4.140115
Thermal printhead cable	4.520378
Printer roller	4.410181
Potential equalisation stud	4.260377





Chapter 7

Technical Data



Technical Data

Technical data subject to change without notice.

Dimensions:	290 x 210 x 69 mm
Weight:	2.9 kg
Mains Supply:	100 to 115 / 220 to 240 VAC, 50/60 Hz
Battery:	Built-in 12 V lead-acid battery (rechargeable)
Battery Capacity:	2 hours normal use
Power Consumption:	Recording: 28 VA max
Leads:	Standard / Cabrera
Paper Speed:	5 / 25 / 50 mm/s (direct)
Sensitivity:	5 /10 / 20 mm/mV, either automatically adjusted or manually selected
Chart Paper:	Thermoreactive - Z-folded, 90 mm wide, perforation 90 mm
Printing Process:	High-resolution thermal printhead, 8 dots per mm
Recording Tracks:	3 channels, positioned at optimal width on 80 mm, automatic baseline adjustment
Automatic Lead Programs:	3 channel representation of 12 simultaneously acquired standard leads
Data Record:	Listing of ECG recording data <i>Version C: ECG measurement results (intervals, amplitudes, electrical axes), Sokolow Index, average complexes with optional measurement reference markings, and interpretation.</i>
ECG Storage:	Circular input memory for 10 s, 12-lead ECG.
Frequency Range of Digital Recorder:	0 to 150 Hz (IEC) 0 to 150 Hz (AHA)
ECG Amplifier:	Simultaneous, synchronous registration of all 9 active electrode signals (= 12 standard leads)
	Sampling frequency: 1000 Hz
	Digital resolution: 5 μ V
	Dynamic range: \pm 10 mVAC
	Max. electrode potential: \pm 300 mVDC
	Time constant: > 3.2 s
	Frequency response: 0.05 to 150 Hz (-3 dB)
	Input impedance: > 10 MOhms



Technical Data (cont.)

Myogram Filter (muscle tremor filter):	25 Hz or 35 Hz, programmable (not active on averaged waveform). The stored ECGs can be printed with or without filter.
Line Frequency Filter:	Distortion-free suppression of superimposed 50 or 60 Hz sinusoidal interferences.
Patient Input:	Fully floating and isolated, defibrillation protected.
Patient Leakage Current:	< 5 μ A
Safety Standard:	CF according to IEC 60601-1 and IEC 60601-2-25
Safety Class:	I according to IEC 60601-1 (with internal power supply)
Environmental Conditions:	Temperature, Operating: 10° to 40°C
	Temperature, Storage: -10° to 50° C
	Relative humidity: 25 to 95% (non condensing)
	Atmospheric pressure: 700 to 1060 hPa
Control Panel:	Rubber keys

AT-1 smartprint only :

External Printer :	12 channel high resolution print-out, standard Centronics connecting cable
--------------------	--

Available Configurations

The AT-1 / AT-1smartprint is available in three versions:

Standard Version:	Unit with ECG recording and printout capabilities.
Version M:	Unit with additional ECG measurement program.
Version C:	Unit with additional ECG Interpretation program (including measurements).





Index

A

Article Numbers 77
Automatic Mode 17, 18

B

Battery Pack 64, 65
Board Removal
 MK 11-10 62
Board Replacement
 MK 11-10 63

C

Calib 34
Check Procedures 48
Configurations 81
Customer Services
 Sales Department 76
 Service Department 76

D

Default Settings 22

E

ECG Isolated Power Supplies 43
ECG Signal 43
Electrode DC Offset 34

F

Fault Diagnosis Chart 46
Filter 24
Functional Overview 41

G

General Check Procedures 48

K

Keyboard 14, 66

M

Manual Mode 19
Memory 42
Motor Speed 43

N

Noise Damping 43



O

Opening the Case 56
Ordering Information 76

P

Paper Handling 37
Paper Mark 43
Paper Tray 60
Patient Cable Resistance 34
Physical Overview 55
Power On Reset 43
Power supply 13
Printer check 49, 50
Printer Removal & Replacement 59
Printer Timing 42
Printhead 36
Printhead Alignment and Printhead Tension 49
Program Memory 42
Proprietary Test Equipment/tools 70

R

Removal and replacement 61

S

Safety Notices 5
Serial EEPROM 42
Service and Sales 3
Settings 20
Spare Parts 77
Stepper Motor Controller 43

T

Technical Data 80
Test Equipment 70
Thermal Printhead Controller 42
Tools 55
Top Housing Removal 56
Top Housing Replacement 57

U

Udif 34
Uoff 34
Uref + 34
Uref - 34

